



# INSTALLATION & OPERATION MANUAL



# EVO ULTRA

COMMERCIAL HOT WATER HEAT PUMP



## Contents

1. Introduction .....	2
2. Unit Dimensions.....	3
3. Safety Instructions .....	4
4. Installation.....	5
4.1 System Installation .....	5
4.2 Plumbing .....	5
4.3 Electrical Connection .....	6
4.4 Initial Start-up .....	6
5. Operation .....	7
5.1 The Controller .....	7
5.2 Operating Functions.....	7
5.2.1 On/Off.....	7
5.2.2 Mode Selection.....	7
5.2.3 Setting the Target Temperature .....	7
5.2.4 Locking the Screen.....	7
5.2.5 Setting a Timer .....	8
5.2.6 Settings.....	8
6. Troubleshooting .....	11
6.1 Fault Table .....	11
7. Appendix.....	14
7.1 Cable Specifications.....	14
7.2 Wiring Diagram .....	15
8. Maintenance .....	16
9. Warranty .....	17

## 1. Introduction

This manual contains information relating to the installation, troubleshooting, operation, and maintenance of this EvoHeat unit. Instructions in this manual must always be followed. Failure to comply with these recommendations will invalidate the warranty. Should you have any questions or require technical support, call the EvoHeat office on 1300 859 933 to speak to our team.

The data and information contained in this manual is correct at the time of publishing and is subject to change without notice. For the most up to date manual, contact EvoHeat directly.



The Evo Ultra is a water to water heat pump that is the perfect solution in applications where chillers and cooling towers are being used for temperature control. When installed in line with the chiller, the Evo Ultra can capture rejected waste from the chiller return lines and utilise this heat to provide FREE HOT WATER!

TECHNICAL DATA			Evo Ultra 64	Evo Ultra 129	Evo Ultra 240
Evaporator Side 20°C/15°C	Heating Capacity	<b>kW</b>	67.1	134.2	222
	Cooling Capacity	<b>kW</b>	50.9	101.9	160
Condenser Side 45°C/55°C	Power Input	<b>kW</b>	15.8	31.6	59.5
	C.O.P		4.24	4.24	3.7
Evaporator Side 20°C/15°C	Heating Capacity	<b>kW</b>	58.6	115.6	190
	Cooling Capacity		40	75.6	114.5
Condenser Side 65°C/75°C	Power Input	<b>kW</b>	19.6	41.7	78.5
	C.O.P		3	2.77	2.42
Voltage/Phase			380-415/3/50	380-415/3/50	380-415/3/50
Max. Running Current	<b>A</b>		50	90	180
Max. Power Input	<b>kW</b>		26	46	98
Noise	<b>dB(A)</b>		68	69	71
Compressor Type		Copeland Scroll ZW Series R134a EVI Scroll			
Compressor No.			2	4	4
Evaporator Water Flow	<b>m³/h</b>		7	20	28
Condenser Water Flow	<b>m³/h</b>		5.1	18.2	38
Refrigerant Type			R134a	R134a	R134a
Max. Outlet Water Temp.	<b>°C</b>		80	80	80
Net Weight	<b>kg</b>		441	866	1050
Net Dimensions (L/W/H)	<b>mm</b>		1172 / 900 / 1365	1600 / 1130 / 1500	2030 / 1250 / 1610

Heating: Heat source side: water inlet/outlet temperature: 20°C/15°C

User side water inlet/outlet temperature: 65°C/75°C

When the units work between 55-85°C, make sure the low-pressure range is between 0.27-0.65MPa and the evaporating temperature is between 7-30°C. The above data is for reference only, specific data is subject to the product nameplate

## 2. Unit Dimensions

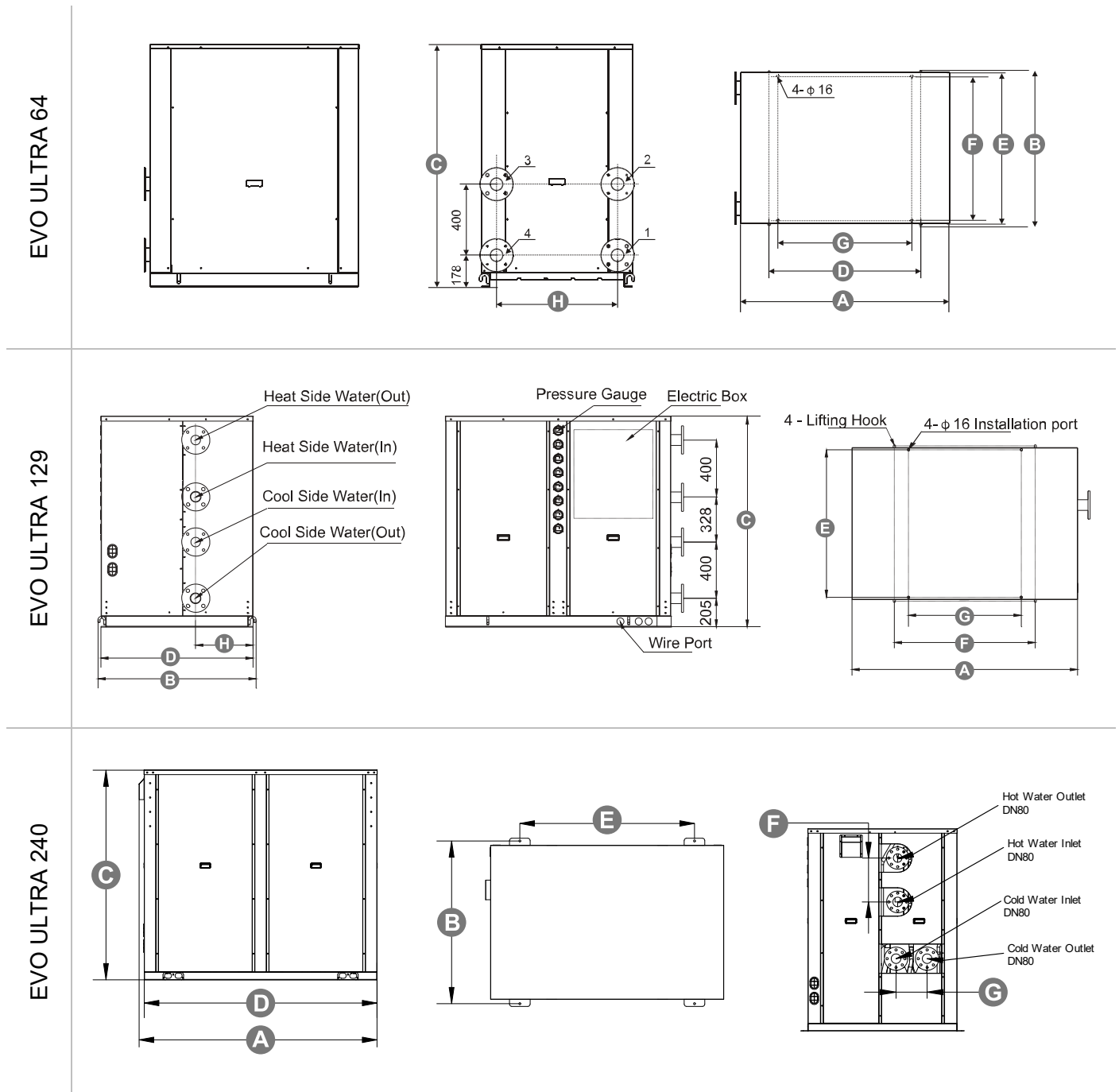

Unit: mm	A (L)	B (W)	C (H)	D	E	F	G	H
<b>Evo Ultra 64</b>	1172	900	1365	850	850	812	750	680
<b>Evo Ultra 129</b>	1600	1130	1500	1080	1050	1000	800	410
<b>Evo Ultra 240</b>	2030	1250	1610	1986	1490	350	245	

### 3. Safety Instructions



Installation, repair, or relocations must only be done by a fully qualified technician. If done incorrectly there is a number of hazards that can occur including fire, electric shock, water leakage and injury.

- A circuit breaker must be installed for the unit.
- Ensure the unit has a good power connection and earthing to avoid the risk of electrical shocks.
- Maintenance and operation must be carried out according to the recommended time and frequencies, as stated in this manual.
- The unit must be stored in a room without any continuously operating ignition sources (for example: open flames, an operating gas appliance)
- Do not pierce or burn the unit.
- If the supply cord is damaged, it must be replaced by a qualified service agent.
- This appliance must be installed in accordance with national wiring regulations.
- Before obtaining access to terminals all supply circuits must be disconnected.
- The unit is equipped with an over-load protection system. After a previous stoppage, the unit will not start for at least 3 minutes.
- For unit cleaning or maintenance, switch off and disconnect the power of the unit.
- Do not install the unit near flammable gas or spray flammable substances near it.
- Ensure the heat pump is installed on a strong and stable platform.
- If the supply cord is damaged, it must be replaced.
- Use genuine standard spare parts only.



## WARNING

### THIS PRODUCT CONTAINS A BUTTON BATTERY

If swallowed, a lithium button battery can cause severe or fatal injuries within 2 hours.

Keep batteries out of reach of children.

If you think batteries may have been swallowed or placed inside any part of the body, seek immediate medical attention.

## 4. Installation

### 4.1 System Installation

- This model can be installed on a concrete base with expansion bolts or installed on the ground or roof by a steel bracket with rubber cushion. Make sure that the units are horizontally placed.
- The units should be installed at a place convenient for installation and maintenance.
- The units should install shock-absorbing devices in case of the shock transferring to the building.

For transit, use four slings longer than 8m when moving the units and use the lifting holes on the bottom board. Put a cushion block at the places of contact in case of damage.

### 4.2 Plumbing

When connecting the water pipeline, you cannot exchange the user side pipeline with the heat source side pipeline. The unit's user side and heat source side direction should be in accordance with the direction as marked on the units. Water pipeline resistance out of the units should be as minimal as possible.

The pipeline must be clean to prevent jamming. Before packing the insulation layer, a leakage test should be conducted.

Adopt the same diameter water pipe as mentioned in the user guide for inlet and outlet connection pipe out of the units. Ensure that the pipeline is full of water and has fine moisture measures when the unit is at work.

The Expansion water tank should be equipped at the highest part of the water pipeline. The water surface of the expansion water tank should be 0.5m or higher than the highest point of water pipeline.

Choose the insulation water tank with suitable volume according to the units heating and cooling capacity and ensure the insulation of pipeline out of the water tank.

If the units have no water pump equipped, please choose the proper water pump according to the units water flow volume on the user guide, making sure the water flow volume satisfies the units requirement. There should be hose connection equipment between the water pump and units. If the water pump is installed outdoors, there should be water-proof and anti-freezing equipment.

An automatic exhaust air valve should be equipped at the highest point of the water pipeline in case of air detention in the pipe; Drainage valve should be equipped at the lowest point of the water pipeline, so it can be convenient for maintenance and drainage.

A Y-type filter should be installed at the circular water pump inlet port of the user side and heat source side in case that impurities may damage the units. The Y-type filter should be detachable for cleansing and maintenance.

Softened water can be better for circular water.

The connection of the water inlet and outlet should be flexible to reduce vibration.

Drain out the water in the pipeline when you will not use the units for a long time in case of freezing.

Do not change the set return water temperature and water tank insulation temperature.

Thermometer and water pressure gauge should be equipped at the units water inlet and outlet port for checking.

User side water should be tap water and the hardness should be less than 20. If not, install an electric hydro treater at the tap water side.

### 4.3 Electrical Connection



Always use a suitably qualified Electrician to perform any electrical work, they must read the manual before connecting.

Ensure all cabling, circuit breakers, and protections are of a suitable size and specification in accordance with electrical wiring legislation for the heater being installed. Ensure to check that there is adequate voltage and current available at the heater connection to run the unit.

- Open the front panel and open the power supply access.
- The power supply must go through the wire access and be connected to the power supply terminals in the controlling box. Then connect the 3-signal wire plugs of the wire controller and main controller.
- If an external water pump is required, please insert the power supply wire into the wire access and connect it to the water pump terminals.
- If an additional auxiliary heater is needed to be controlled by the heat pump controller, the relay (or power) of the aux-heater must be connected to the relevant output of the controller.

### 4.4 Initial Start-up

#### Pre-Start Inspection

- Check the indoor unit, make sure that the pipe connection is done correctly, and the relevant valves are open.
- Check the water loop to ensure that the water inside of the expansion tank is filled to an appropriate level, the water supply is working and that the water loop is full of water & free of trapped air. Make sure there is good insulation for the water pipe.
- Check the electrical wiring. Make sure that the power voltage is normal, the screws are fastened, the wiring is made in line with the diagram and that the earthing is connected.
- Check that the heat pump includes all the screws and components, and that they are in good order. When powering the unit on, review the indicator on the controller to see if there is any indication of failure. The gas gauge can be connected to the check valve to see the high pressure (or low pressure) of the system during trial running.

#### Trial Operation

- Start the heat pump by pressing the ON/OFF key on the controller. Check whether the water pump is running, if it runs normally there will be 0.2MPa on the water pressure meter.
- When the water pump has ran for a minute, the compressor will start. Listen for any strange sounds from the compressor, if an abnormal sound occurs please stop the unit and check the compressor. If the compressor runs well, please look for the pressure meter of the refrigerant.
- Check whether the power input and running current is in line with the manual. If not, please stop and check.
- Adjust the valved on the water loop to make sure that the hot (cool) water supply to each door is good and meets the requirements of heating (or cooling).
- Review whether the outlet water temperature is stable.
- The parameters of the controller are set by the factory, the user cannot change these themselves.



## 5. Operation

### 5.1 The Controller

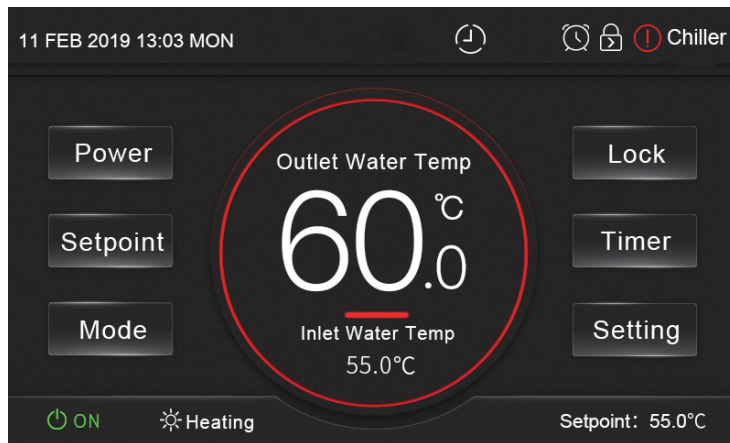

<b>Power</b>	Turn the unit on or off
<b>Setpoint</b>	Set the target temperature
<b>Mode</b>	Select heating or cooling mode
<b>Lock</b>	Lock or unlock the screen
<b>Timer</b>	Enter timer setting menu (Temp Timer, Power Timer)
<b>Setting</b>	Enter function menu (Status, Parameter, Failures & Time)
Inlet Setpoint:	Target temperature of inlet water
11 FEB 2019 13:03 MON	Unit's set date & time
<b>Display Circle</b>	Blue: Cooling mode, Red: Heating Mode, Grey: Off

Icons will appear at the top right of the screen indicating certain functions that are enabled, or if there has been an error with the system.

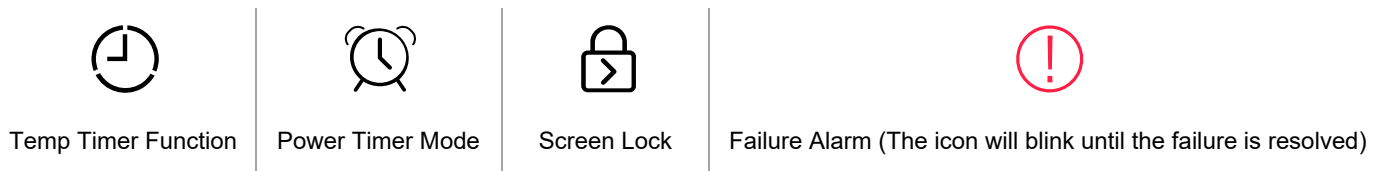

### 5.2 Operating Functions

#### 5.2.1 On/Off

From the main menu, simply press the '**Power**' button to turn the unit on or off.

#### 5.2.2 Mode Selection

From the main menu, pressing the '**Mode**' button will allow you to select either heating or cooling mode. The status bar (bottom of the screen) will display the unit's current operating state.

The display circle will appear as red for heating, or blue for cooling. If the unit is off, it will simply be grey.

#### 5.2.3 Setting the Target Temperature

To adjust the target temperature value, first choose a running mode (heating or cooling), then press the '**Setpoint**' button to enter the parameter setting screen.

Enter the required parameter according to the effective range which is displayed at the bottom of the screen.

#### 5.2.4 Locking the Screen

From the main menu, press the '**Lock**' button to lock the controller screen and prevent unauthorised people accessing the controls.

When the screen is locked a small lock symbol will appear on the top right of the main menu.

To unlock the screen, press the '**Lock**' button again and enter the password **22** which will unlock the screen and remove the lock symbol.



**5.2.5 Setting a Timer**

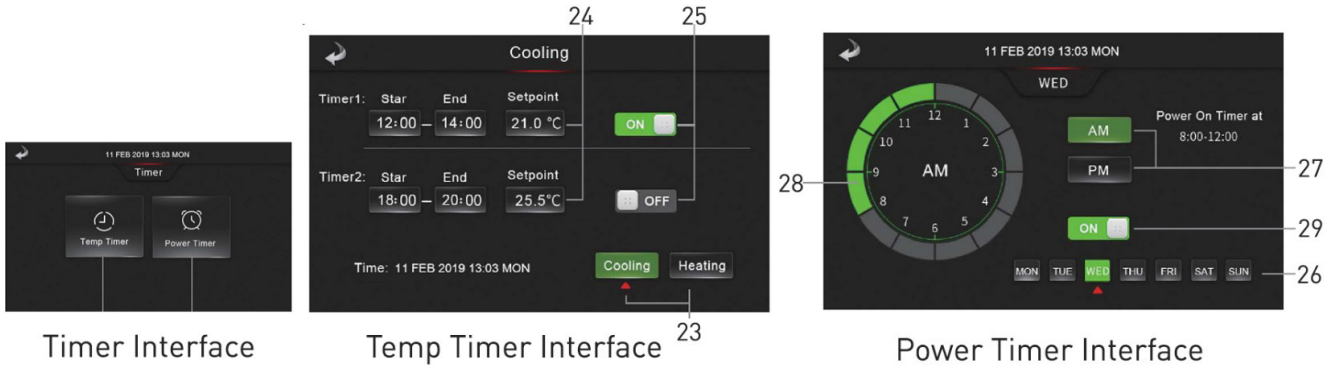

After pressing the 'Timer button from the main interface, select from Temp Timer or Power Timer.

**5.2.5.1 Temperature Timers**

This function enabled time-sharing temperature control, which is two segments of staggered peak temperature control, and allows the target temperature of two segments of different time periods to be set according to different modes.

Press (23) to select from cooling or heating mode, then enter the start time, ending time and the target temperature setpoint value (24). Press (25) to enable or disable the settings.

**5.2.5.2 Power Timer**

This function allows you to set the opening time of the unit for each day of the week.

Press (26) to select the day of the week, then (27) to select AM or PM, after this press (28) to select the time, and finally select (29) to enable or turn off the setting.

**5.2.6 Settings**

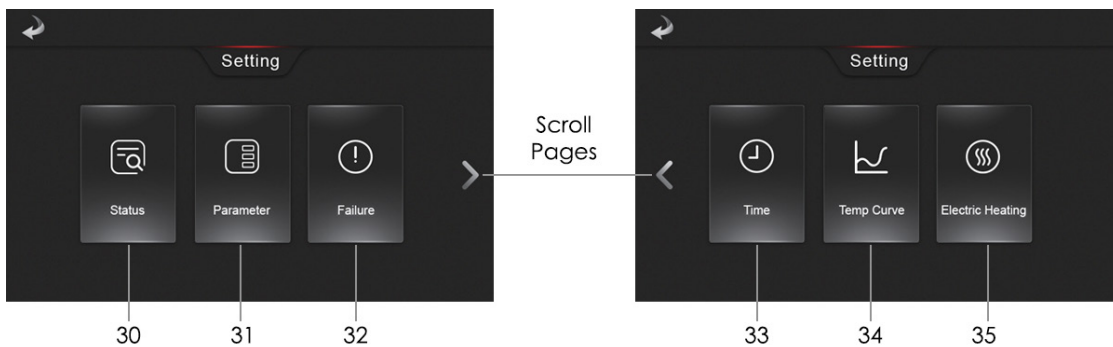

After pressing the 'Setting' button on the main menu, you can select from a range of functions.

**5.2.6.1 Status**

Press Status (30) to choose from Running Status or Unit Status.

**Running Status**

See below image.

**Unit Status**

Enter the password **22** to inquire the unit status parameter. Press one of the 4 buttons to inquire relevant parameters.

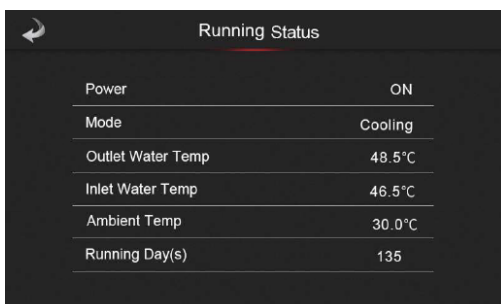

Running Status Screen

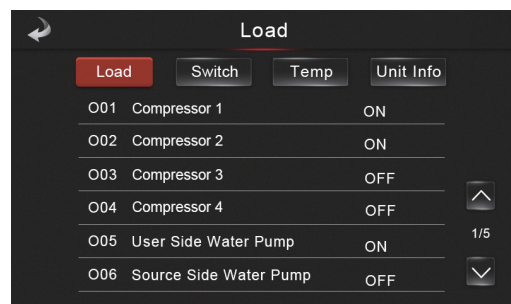

Unit Status Screen

### 5.2.6.2 Parameters

After pressing the parameter button (31) from the settings menu, enter the password **22** to jump to the Installer Parameter interface for inquiring about relevant parameters.

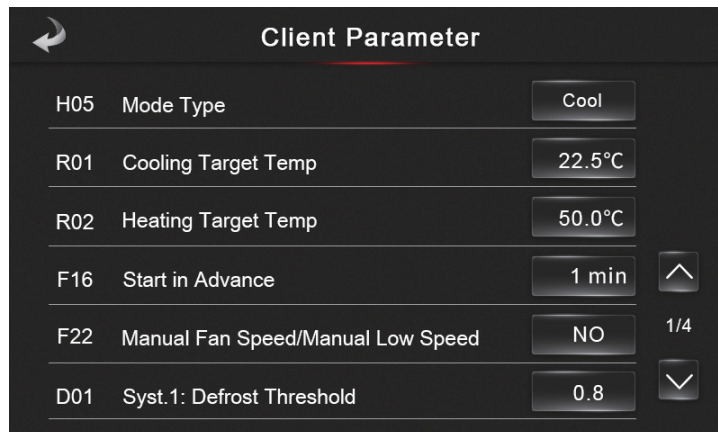

### 5.2.6.3 Failure

When a failure is present, the red failure alarm will be flashing on the main menu. First press '**Settings**' then '**Failure**' to view the failure records.

Once maintenance has been completed, press the 'clear' button to delete the failure history.

### 5.2.6.4 Time

To change the system's date & time, click on the input field and enter the correct values. Press 'save' in the top right corner to save the settings.

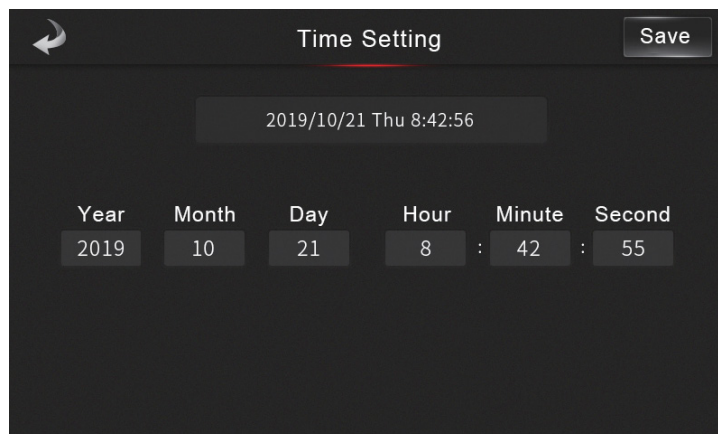

### 5.2.6.5 Temperature Curve

Press (34) to view the inlet/outlet temperature curve.

- This curve function records the water inlet outlet temperature.
- Temperature data is collected every 5 minutes, and the 12 sets of temperature data are saved every hour. Timekeeping is made from the latest data saving. If the power is disrupted before all 12 data sets have been collected the data will not be saved.
- Only curve for the electricity status is recorded, the outage status will not be saved.
- The value of the abscissa indicates the time from the point on the curve to the current time point. The leftmost point on the first page (0 on the abscissa is the latest temperature record).
- Temperature curve record is provided with power off memory function; in the case of a disturbed curve recording and display, when the unit is next powered on the wire controller will automatically clear the history curve record and the curve recording function will restore to a normal state.

### 5.2.6.6 Electric Heating

In the settings menu, the Electric Heating option will display as 'OFF Electric Heating'. Make sure that the unit is firstly in heating mode, then press the electric heating button to head to its interface. Click the button to turn it on to activate the electric auxiliary heating mode. Turn off the function by tapping the button again.

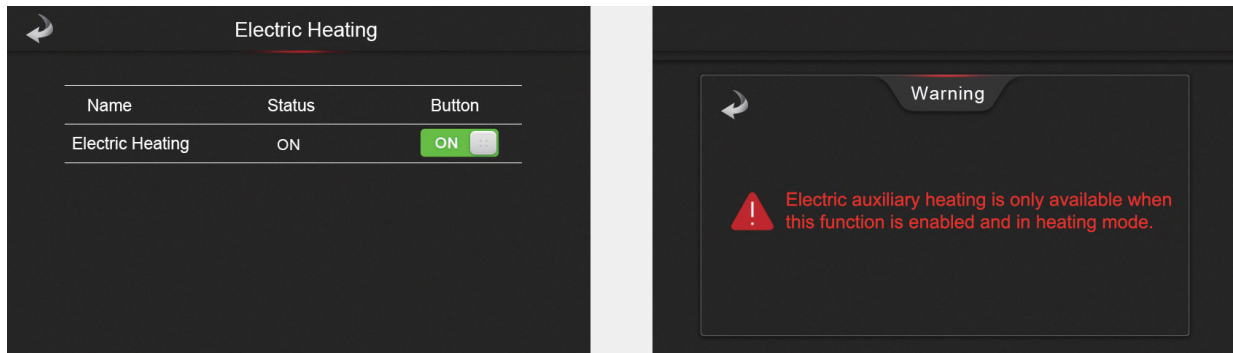

### 5.2.6.8 Display Calibration

Enter the Unit status menu in the following order.  
Main Interface → Setting → Status → Unit Status

The password it will ask for is: **22**

Click the screen in the bottom left corner over 10 times within 4 seconds to bring up the display calibration interface. Click the blank squares to check whether there are bad spots within the screen. Green spots are normal.

To exit, click the screen in the bottom right corner.

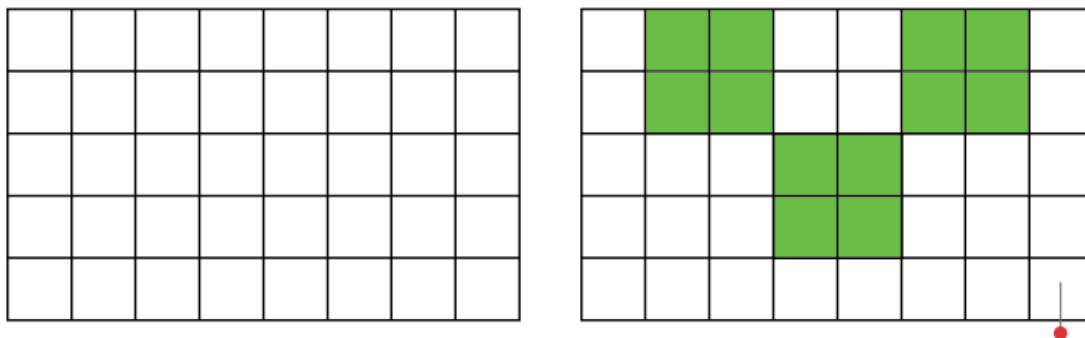

## 6. Troubleshooting

### 6.1 Fault Table

Protection/failure	Codes	Causes	Removal methods
Communication Fault	E08	Abnormal communication between wire controller and the main board	Inspect whether the wire controller, the main board and the connection are reliable
Wire controller don't Match mainboard	E084		
DC Fan 1 Communication Fault	E081	Communication of the speed regulation module 1 with main board is abnormal	Check the speed regulation module 1 and the main board to see if connections are normal and reliable.
Syst1: High Pressure Prot.	E11	The high-voltage switch of the system is disconnected	Inspect System 1 voltage switch and refrigerating circuit for any failure
Syst2: High Pressure Prot.	E21	The high-voltage switch of the system is disconnected	Inspect System 2 voltage switch and refrigerating circuit for any failure
Syst1: Low Pressure Prot.	E12	The low-voltage switch of the system is disconnected	Inspect System 1 voltage switch and refrigerating circuit for any failure
Syst2: Low Pressure Prot.	E22	The low-voltage switch of the system is disconnected	Inspect System 2 voltage switch and refrigerating circuit for any failure
Water Flow Switch Prot.	E032	The water system has little or no water	Inspect whether the water flow of the water pipe conforms to related requirements and check the water pump for any damages
Electric Heater Overheating	E04	Electric heating overheat protection switch is disconnected	Inspect whether the electric heating is under operation condition of over 150°C for a long time
Level 1 Winter Antifreezing Prot.	E19	Excessively low environment temperature	
Level 2 Winter Antifreezing Prot.	E29	Excessively low environment temperature	
Syst1: User Side Antifreezing Prot.	E171	The water flow of the system is insufficient	Inspect whether the water flow of the water pipe conforms to related requirements and check the water pump for any blockage
Syst2: User Side Antifreezing Prot.	E271	The water flow of the system is insufficient	Inspect whether the water flow of the water pipe conforms to related requirements and check the water pump for any blockage
Water(Out) High Temp Prot.	E09	Excessively high water outlet temperature	
Fan 1 Overload Prot.	E103	Fan 1 thermal overload	Check if fan 1 is running normally
Fan 2 Overload Prot.	E203	Fan 2 thermal overload	Check if fan 2 is running normally
Syst1: Exhaust Air High Temp Prot.	P182	System compressor is overloaded	Inspect whether the operation of System 1 compressor is normal
Syst2: Exhaust Air High Temp Prot.	P282	System compressor is overloaded	Inspect whether the operation of System 2 compressor is normal
Water (In/Out) Temp Excess Diff Prot.	E06	The water flow of the system is insufficient, the pressure difference of the water system is small	Inspect whether the water flow of the water pipe conforms to related requirements and check the water pump for any blockage
Water(Out) Low Temp Prot.	E05	Excessively low water outlet temperature	
DC Fan 2 Communication Fault	E082	Communication of the speed regulation module 2 with main board is abnormal	Check the speed regulation module 2 and the main board and if their connections are normal and reliable.
Fan 1 Overcurrent Speed Limit	E103	DC Fan 1 running current too large	Check if fan 1 is running normally
Fan 2 Overcurrent Speed Limit	E203	DC Fan 2 running current too large	Check if fan 2 is running normally
Syst1: High Pressure Prot. 3+	E11	The high-voltage switch of the system is disconnected	Inspect System 1 voltage switch and refrigerating circuit for any failure
Syst2: High Pressure Prot. 3+	E21	The high-voltage switch of the system is disconnected	Inspect System 2 voltage switch and refrigerating circuit for any failure
Syst1: Low Pressure Prot. 3+	E12	The low-voltage switch of the system is disconnected	Inspect System 1 voltage switch and refrigerating circuit for any failure
Syst2: Low Pressure Prot. 3+	E22	The low-voltage switch of the system is disconnected	Inspect System 2 voltage switch and refrigerating circuit for any failure

Protection/fault	Codes	Causes	Removal methods
Water Flow Switch Prot. 3+	E032	The water system has no or only few water	Inspect whether the water flow of the water pipe conforms to related requirements and check the water pump for any damages
Electric Heater Overheating 3+	E04	Electric heating overheat protection switch is disconnected	Inspect whether the electric heating is under operation condition of over 150°C for a long time
Syst1: User Side Antifreezing Prot. 3+	E171	The water flow of the system is insufficient	Inspect whether the water flow of the water pipe conforms to related requirements and check the water pump for any blockage
Syst2: User Side Antifreezing Prot. 3+	E271	The water flow of the system is insufficient	Inspect whether the water flow of the water pipe conforms to related requirements and check the water pump for any blockage
Water(Out) High Temp Prot. 3+	E09	Excessively high water outlet temperature	
Syst1: Exhaust Air High Temp Prot. 3+	P182	The system compressor is overloaded	Inspect whether the operation of System 1 compressor is normal
Syst2: Exhaust Air High Temp Prot. 3+	P282	The system compressor is overloaded	Inspect whether the operation of System 2 compressor is normal
Water (In/Out) Temp Excess Diff Prot. 3+	E06	The water flow of the system is insufficient, the pressure difference of the water system is small	Inspect whether the water flow of the water pipe conforms to related requirements and check the water pump for any blockage
Water(Out) Low Temp Prot. 3+	E05	Excessively low water outlet temperature	
Fan 1 Fault Prot.	E012	DC Fan 1 fault	Check if fan 1 is running normally
Fan 2 Fault Prot.	E022	DC Fan 2 fault	Check if fan 2 is running normally
Water (In) Sensor Fault	P01	Temperature sensor open or short circuited	Check and replace inlet water temperature sensor
Water (Out) Sensor Fault	P02	Temperature sensor open or short circuited	Check and replace outlet water temperature sensor
Syst1: Coil Sensor Fault	P15	Temperature sensor open or short circuited	Check and replace the system 1 coil 1 temperature sensor
A.T. Sensor Fault	P04	Temperature sensor open or short circuited	Check and replace the ambient temperature sensor
Syst1: Suction Temp Sensor Fault	P17	Temperature sensor open or short circuited	Check and replace the system 1 suction temperature sensor
Syst1: Antifreezing Temp Sensor 1 Fault	P191	Temperature sensor open or short circuited	Check and replace the system 1 antifreeze 1 temperature sensor
Syst2:Coil Sensor Fault	P25	Temperature sensor open or short circuited	Check and replace the system 2 coil 1 temperature sensor
Syst1: Antifreezing Temp Sensor 2 Fault	P192	Temperature sensor open or short circuited	Check and replace the system 1 antifreeze 2 temperature sensor
Syst2: Antifreezing Temp Sensor 2 Fault	P292	Temperature sensor open or short circuited	Check and replace the system 2 antifreeze 2 temperature sensor
Syst1: EVI(In) Temp Sensor Fault	P101	Temperature sensor open or short circuited	Check and replace the system 1 EVI inlet temperature sensor
Syst1: EVI(Out) Temp Sensor Fault	P102	Temperature sensor open or short circuited	Check and replace the system 1 EVI outlet temperature sensor
Syst1: Exhaust Air Temp Sensor Fault	P181	Temperature sensor open or short circuited	Check and replace the system 1 exhaust temperature sensor
Syst1: Low Pressure Sensor Fault	PP11	The sensor is open or short circuited	Check and replace system 1 low pressure sensor
Syst2: Suction Temp Sensor Fault	P27	Temperature sensor open or short circuited	Check and replace the system 2 suction temperature sensor
Syst2: Antifreezing Temp Sensor 1 Fault	P291	Temperature sensor open or short circuited	Check and replace the system 2 antifreeze 1 temperature sensor
Syst1: High Pressure Sensor Fault	PP12	The sensor is open or short circuited	Check and replace the system 1 high pressure sensor
Syst2: High Pressure Sensor Fault	PP22	The sensor is open or short circuited	Check and replace the system 2 high pressure sensor



Protection/fault	Codes	Causes	Removal methods
Syst2: Exhaust Air Temp Sensor Fault	P281	The temperature sensor is open or short circuited	Check and replace the system 2 exhaust temperature sensor
Syst2: Low Pressure Sensor Fault	PP21	The sensor is open or short circuited	Check and replace System 2 low-voltage sensor
Syst2: EVI(In) Temp Sensor Fault	P201	The temperature sensor is open or short circuited	Check and replace System 2 EVI inlet temperature sensor
Syst2: EVI(Out) Temp Sensor Fault	P202	The temperature sensor is open or short circuited	Check and replace System 2 EVI outlet temperature sensor
Low A.T. Power-Off Prot.	TP	Excessively low environment temperature	
Syst1: Coil Temp Sensor Fault 2	P154	The temperature sensor is open or short circuited	Check and replace the system 1 coil 2 temperature sensor
Syst2: Coil Temp Sensor Fault 2	P254	The temperature sensor is open or short circuited	Check and replace the system 2 coil 2 temperature sensor
Syst1: Comp. Overcurrent Prot.	E101	System 1 compressor running current too large	Check if the current is too high
Syst2: Comp. Overcurrent Prot.	E201	System 2 compressor running current is too large	Check if the current is too high
Syst1: Comp. Overcurrent Prot. 3+	E101	System 1 compressor running current is too large	Check if the current is too high
Syst2: Comp. Overcurrent Prot. 3+	E201	System 2 compressor running current is too large	Check if the current is too high
Syst1: Comp. Start Fault	E132	System 1 compressor failed to start	
Syst2: Comp. Start Fault	E232	System 2 compressor failed to start	
Syst1: Comp. Stop Fault	E133	System 1 compressor failed to stop	
Syst2: Comp. Stop Fault	E233	System 2 compressor failed to stop	
Power Down Memory	EE1	Loss of power when power on	Automatic recovery after 3 minutes of power on

## 7. Appendix

### 7.1 Cable Specifications

Single Phase Unit					
Nameplate maximum current	Phase line	Earth Line	MCB	Creepage Protector	Signal Line
No more than 10A	2 x 1.5mm <sup>2</sup>	1.5mm <sup>2</sup>	20A	30mA less than 0.1 sec	n x 0.5mm <sup>2</sup>
10~16A	2 x 2.5mm <sup>2</sup>	2.5mm <sup>2</sup>	32A		
16~25A	2 x 4mm <sup>2</sup>	4mm <sup>2</sup>	40A		
25~32A	2 x 6mm <sup>2</sup>	6mm <sup>2</sup>	40A		
32~40A	2 x 10mm <sup>2</sup>	10mm <sup>2</sup>	63A		
40~63A	2 x 16mm <sup>2</sup>	16mm <sup>2</sup>	80A		
63~75A	2 x 25mm <sup>2</sup>	25mm <sup>2</sup>	100A		
75~101A	2 x 25mm <sup>2</sup>	25mm <sup>2</sup>	125A		
101~123A	2 x 35mm <sup>2</sup>	35mm <sup>2</sup>	160A		
123~148A	2 x 50mm <sup>2</sup>	50mm <sup>2</sup>	225A		
148~186A	2 x 70mm <sup>2</sup>	70mm <sup>2</sup>	250A		
186~224A	2 x 95mm <sup>2</sup>	95mm <sup>2</sup>	280A		

Three Phase Unit					
Nameplate maximum current	Phase line	Earth Line	MCB	Creepage Protector	Signal Line
No more than 10A	3 x 1.5mm <sup>2</sup>	1.5mm <sup>2</sup>	20A	30mA less than 0.1 sec	n x 0.5mm <sup>2</sup>
10~16A	3 x 2.5mm <sup>2</sup>	2.5mm <sup>2</sup>	32A		
16~25A	3 x 4mm <sup>2</sup>	4mm <sup>2</sup>	40A		
25~32A	3 x 6mm <sup>2</sup>	6mm <sup>2</sup>	40A		
32~40A	3 x 10mm <sup>2</sup>	10mm <sup>2</sup>	63A		
40~63A	3 x 16mm <sup>2</sup>	10mm <sup>2</sup>	80A		
63~75A	3 x 25mm <sup>2</sup>	16mm <sup>2</sup>	100A		
75~101A	3 x 25mm <sup>2</sup>	16mm <sup>2</sup>	125A		
101~123A	3 x 35mm <sup>2</sup>	16mm <sup>2</sup>	160A		
123~148A	3 x 50mm <sup>2</sup>	25mm <sup>2</sup>	225A		
148~186A	2 x 70mm <sup>2</sup>	35mm <sup>2</sup>	250A		
186~224A	2 x 95mm <sup>2</sup>	50mm <sup>2</sup>	280A		

If the unit is installed outdoors, use a UV resistant cable.

The above specification is for reference only. For specific wire and breaker models please check the corresponding factory standard and actual installation requirement



**7.2 Wiring Diagram**

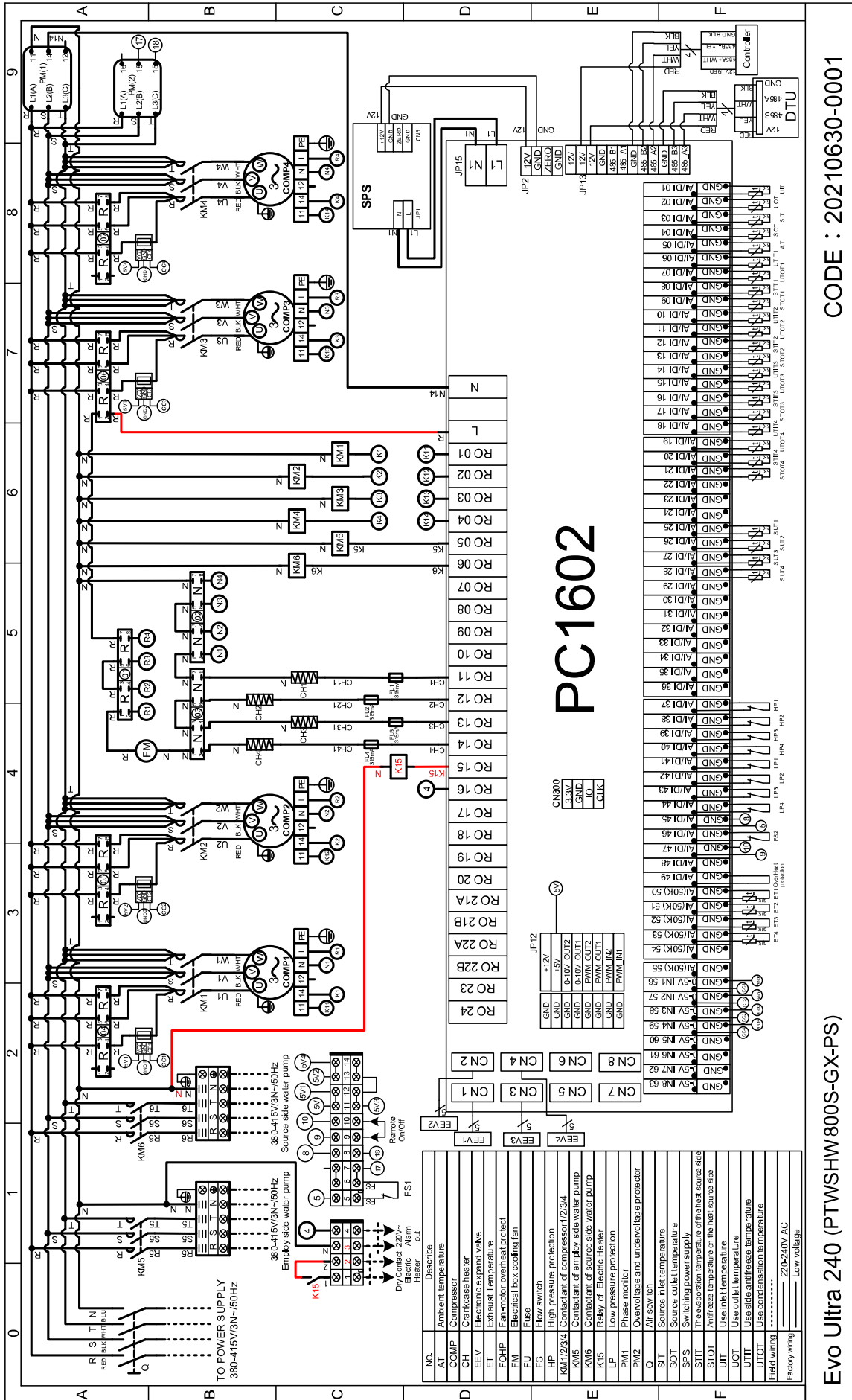

CODE : 20210630-0001

Evo Ultra 240 (PTWSHW 800S-GX-PS)

## 8. Maintenance



### DO I NEED TO GET MY UNIT SERVICED?

It is recommended that you get your EvoHeat unit serviced once a year by your local certified air conditioning or refrigeration technician. If your unit is located in a coastal area, more frequent maintenance may be necessary. During the service, they will check the operational pressures of the refrigeration system and give the unit and fins a good clean to ensure maximum performance.



### DO WE HAVE RECOMMENDED SERVICE AGENTS?

EvoHeat have a large database of recommended service agents. Please contact EvoHeat tech support on 1300 859 933 for your local service agent details.



### SHOULD I CHECK MY UNIT REGULARLY?

We recommend you check your unit regularly to avoid potential issues and damage to your heat pump.

Check the water inlet/outlets often for leaks. You should avoid the condition of no water or air entering into the system, as this will influence unit's performance and reliability.

You should clear the pool/spa filter regularly to avoid damage to the unit as a result of the dirty or clogged filter.



### WHAT SHOULD I BE CHECKING REGULARLY?

The area around the unit should be dry, clean and well ventilated. Make sure there is nothing blocking the airflow of the heater e.g. Leaf litter.

Discharge all water in the water pump and water system, so that freezing of the water in the pump or water system does not occur. You should discharge the water at the bottom of water pump if the unit will not be used for an extended period. You should check the unit thoroughly and fill the system with water fully before using it for the first time after a period of time.

Check the power supply and cable connection often, should the unit begin to operate abnormally, switch it off and contact the qualified technician

## 9. Warranty



### Refer to the EvoHeat website for warranty details

- Australia: <https://evoheat.com.au/warranty-terms/>
- South East Asia: <http://evoheat.com.sg/warranty/>

1. Warranty terms are from date of purchase.
2. This warranty excludes any defect or injury caused by or resulting from misuse, abuse, neglect, accidental damage, improper voltage, vermin infestation, incompetent installation, any fault not attributable to faulty manufacture or parts, any modifications which affect the reliability or performance of the unit.
3. This warranty does not cover the following:
  - a. Natural Disasters (hail, lightning, flood, fire etc.)
  - b. Rust or damage to paintwork caused by a corrosive atmosphere
  - c. When serviced by an unauthorized person without the permission of Evo Industries
  - d. When a unit is installed by an unqualified person
  - e. Where a unit is incorrectly installed
  - f. When failure occurs due to improper or faulty installation
  - g. Failure due to improper maintenance (refer Operating Instructions)
  - h. 'No Fault Found' service calls where the perceived problem is explained within the operation instructions.
  - i. Costs associated with delivery, handling, freighting, or damage to the product in transit.
4. If warranty service is required, you should:
  - a. contact Evo Industries Australia on 1300 859 933 or via our Contact page on our web site
  - b. provide a copy of your receipt as proof of purchase
  - c. have completed the online *Warranty Registration Form*
5. Onsite technical service is available within the normal operating area of your Evo Authorised Service Agents. Service outside this area will incur a traveling fee.
6. Unless otherwise specified to the purchaser, the benefits conferred by this express warranty and additional to all other conditions, warranties, rights and remedies expressed or implied by the Trade Practices Act 1974 and similar consumer protection provisions contained in legislation of the States and Territories and all other obligations and liabilities on the part of the manufacturer or supplier and nothing contained herein shall restrict or modify such rights, remedies, obligations or liabilities.

**REGISTER YOUR WARRANTY**

EvoHeat highly recommend customers complete their warranty details online to ensure efficient warranty claim processing.

To register your warranty, scan our QR Code or head to our website and fill in the Warranty Registration Form: <https://evoheat.com.au/warranty-registration/>

