



EVO FLOW MANUAL



Installation & Operation

**Read this manual carefully before
installing or operating this unit**

Contents

1. Safety precautions	1
2. Specification	2
3. Installation and Connection	5
4. Usage and Operation	10
5. Maintenance	16
6. Excursus	18
7. Appendix	20

1-Safety precautions



**ELECTRICAL POWER MUST BE SWITCHED OFF
BEFORE STARTING ANY WORK ON JUNCTION BOXES**

The aim of this manual is to provide instructions for installation, commissioning, operation.

WARNING !

The installation, commissioning and maintenance of these machines should be performed by qualified personnel having a good knowledge of standards and local regulations, as well as experience of this type of equipment.

WARNING !

Any wiring produced on site must comply with local electrical regulations.

WARNING !

Ensure that the electrical supply corresponds to the specification indicated on the unit's maker's plate before proceeding with the connection in accordance with the wiring diagram supplied.

WARNING !

The unit must be **EARTHED** to avoid any risks caused by insulation defects.

WARNING !

No wiring must come in contact with the heat source or the fan rotating parts.

WARNING !

Preparation for shutting down the unit for a prolonged period if the installation does not contain glycol, the evaporator and the chilled water pipes need to be carefully and completely drained of water.

Take care !

The unit should be handled using lifting and handling equipment appropriate to the unit's size and weight.

Take care !

It is forbidden to start any work on the electrical components without switching off the electrical supply to the unit.

Take care !

It is forbidden to start any work on the electrical components if water or high humidity is present on the installation site.

Take care !

When the unit is being connected, ensure that no impurities are introduced into the pipe work and the water circuits.

Take care !

A mesh filter must be provided on the hydraulic pump and in exchanger water inlets.

The Manufacturer's warranty will not apply if the installation recommendations listed in this manual are not followed.

2-Specification

2.1 Performance data of the Unit

Model	GS	10	14	17	14-3
Heating Capacity	kW	10.0	14.5	17.8	14.5
	BTU/h	34000	50000	60700	50000
Cooling Capacity	kW	8.5	11.0	13.0	11.0
	BTU/h	29000	38000	44000	38000
Heating Power Input	kW	2.0	2.8	3.4	2.8
Cooling Power Input	kW	2.2	2.8	3.3	2.8
Heating Running Current	A	8.5	12.3	14.8	5.0
Cooling Running Current	A	9.3	12.2	14.3	5.0
Super Heater Capacity	kW	1.2	1.6	1.8	1.6
Pump of super heater power input	kW	0.1	0.1	0.1	0.1
water head	m	5.0	5.0	5.0	5.0
Power Supply		230V~/50Hz	230V~/50Hz	230V~/50Hz	380V/3N~/50Hz
Compressor	Type		Rotary	Scroll	Scroll
	Number		1	1	1
Heat source	Type		Plate	Plate	Plate
	Water Flow Volume	m ³ /h	2.1	2.8	3.3
	Water Pressure Drop	kPa	13	13	14.5
	Water Connection(In/Out)	Inch	1	1	1
	pump	kW	0.2	0.2	0.2
	water head	m	6	6	5
Using side	Type		Plate	Plate	Plate
	Water Flow Volume	m ³ /h	1.5	2.1	2.4
	Water Pressure Drop	kPa	11	18	21
	Water Connection(In/Out)	Inch	1	1	1
	Pump	kW	0.1	0.1	0.2
	water head	m	4.5	4.5	6
Noise	dB(A)	38	40	42	40
Unit Net Dimensions(L/W/H)	mm	see the drawing of the units			
Unit Shipping Dimensions(L/W/H)	mm	see package label			
Net Weight	kg	see nameplate			
Shipping Weight	kg	see package label			

■ Heating: Using Side Water Temp.(In/Out):30°C/35°C;Heat Source Water Temp.(In/Out):10°C/— ;

■ Cooling: Using Side Water Temp.(In/Out):12°C/7°C;Heat Source Water Temp.(In/Out):25°C/30°C.

Super Heating Capacity is the standard parameter. The hot water capacity of super heating is the capacity in an hour in cooling in standard condition. (the water temperature is heated from 20°C to 50°C)

2-Specification

2.1 Performance data of the Unit

Model	GS	17-3	19	22
Heating Capacity	kW	17.8	19.3	22.0
	BTU/h	60700	65800	75000
Cooling Capacity	kW	13.0	15.0	17.0
	BTU/h	44000	52000	60000
Heating Power Input	kW	3.4	3.7	4.3
Cooling Power Input	kW	3.3	3.8	4.3
Heating Running Current	A	6.1	6.6	7.6
Cooling Running Current	A	5.9	6.8	7.7
Super Heater Capacity	kW	1.8	2.1	2.3
Pump of super heater power input	kW	0.1	0.1	0.1
water head	m	5.0	5.0	5.0
Power Supply		380V/3N~/50Hz	380V/3N~/50Hz	380V/3N~/50Hz
Compressor	Type		Scroll	Scroll
	Number		1	1
Heat source	Type		Plate	Plate
	Water Flow Volume	m ³ /h	3.3	3.7
	Water Pressure Drop	kPa	14.5	16
	Water Connection(In/Out)	Inch	1	1
	pump	kW	0.2	0.2
	water head	m	5	5
Using side	Type		Plate	Plate
	Water Flow Volume	m ³ /h	2.4	2.7
	Water Pressure Drop	kPa	21	25
	Water Connection(In/Out)	Inch	1	1
	Pump	kW	0.2	0.2
	water head	m	6	6
Noise	dB(A)	42	42	44
Unit Net Dimensions(L/W/H)	mm	see the drawing of the units		
Unit Shipping Dimensions(L/W/H)	mm	see package label		
Net Weight	kg	see nameplate		
Shipping Weight	kg	see package label		

■ Heating: Using Side Water Temp.(In/Out):30℃/35℃;Heat Source Water Temp.(In/Out):10℃/— ;

■ Cooling: Using Side Water Temp.(In/Out):12℃/7℃;Heat Source Water Temp.(In/Out):25℃/30℃.

Super Heating Capacity is the standard parameter. The hot water capacity of super heating is the capacity in an hour in cooling in standard condition. (the water temperature is heated from 20℃ to 50℃)

2-Specification

2.2 The dimensions for the Unit

GS10 to GS17

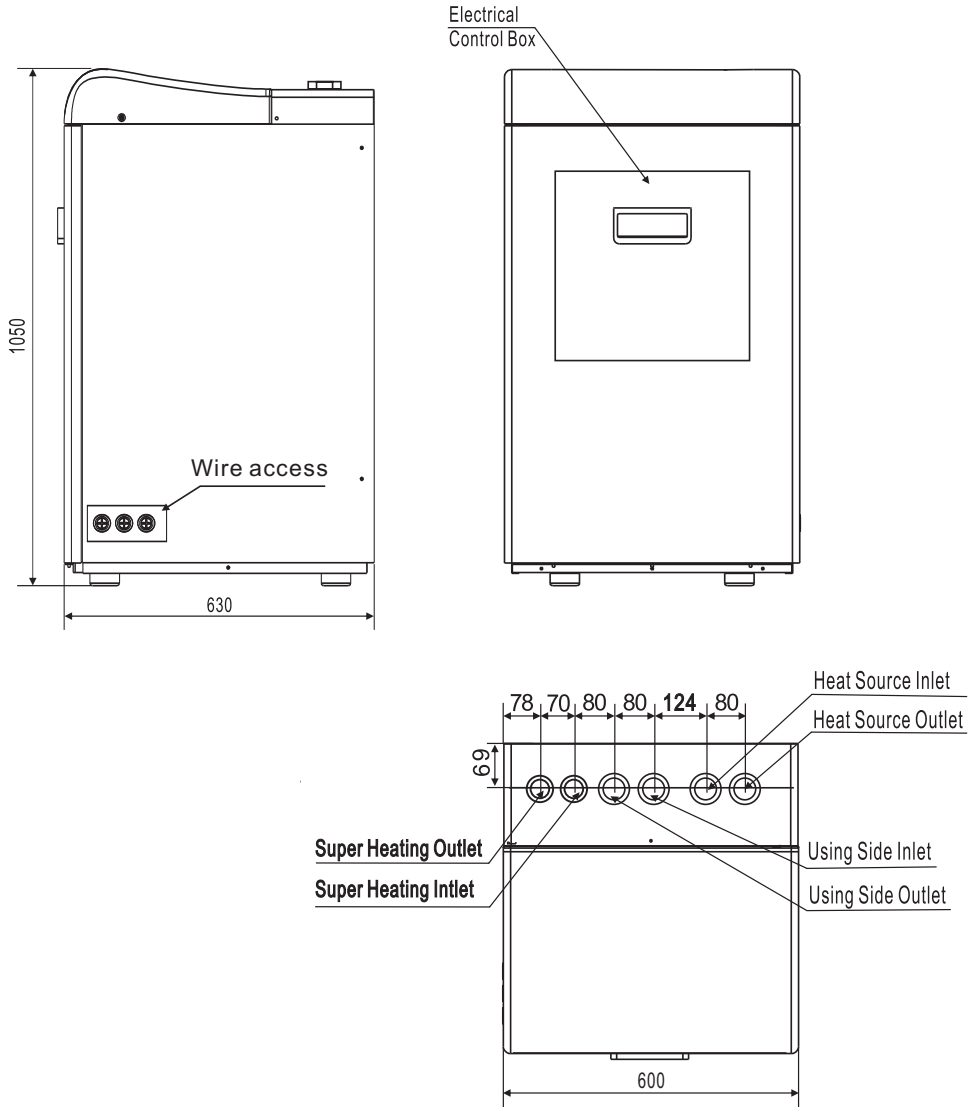

3-Installation and connection

3.1 Installation:

Heat pump & Fan coil & Hot water

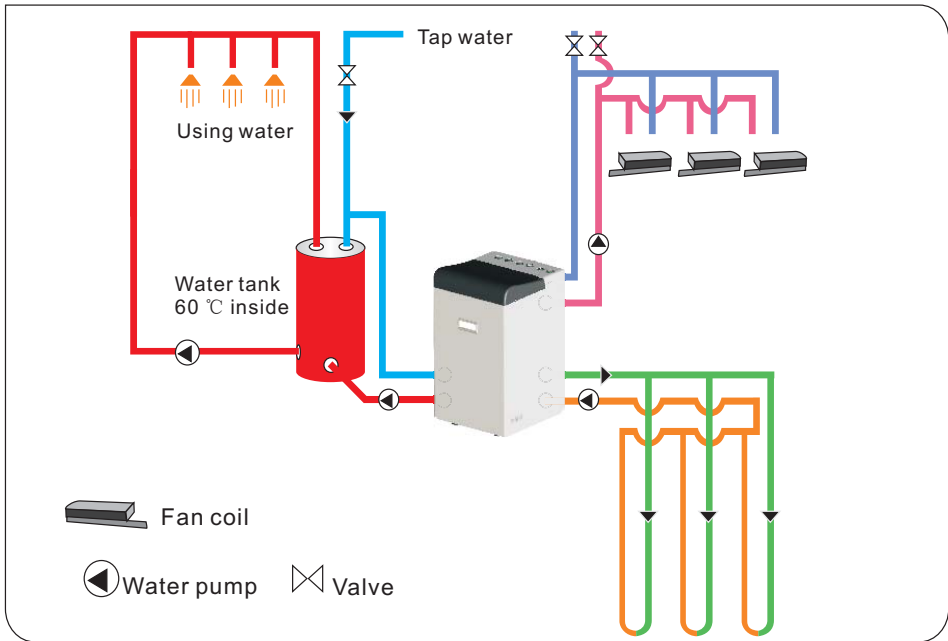

Heat pump & Fan coil & Hot water & floor heating

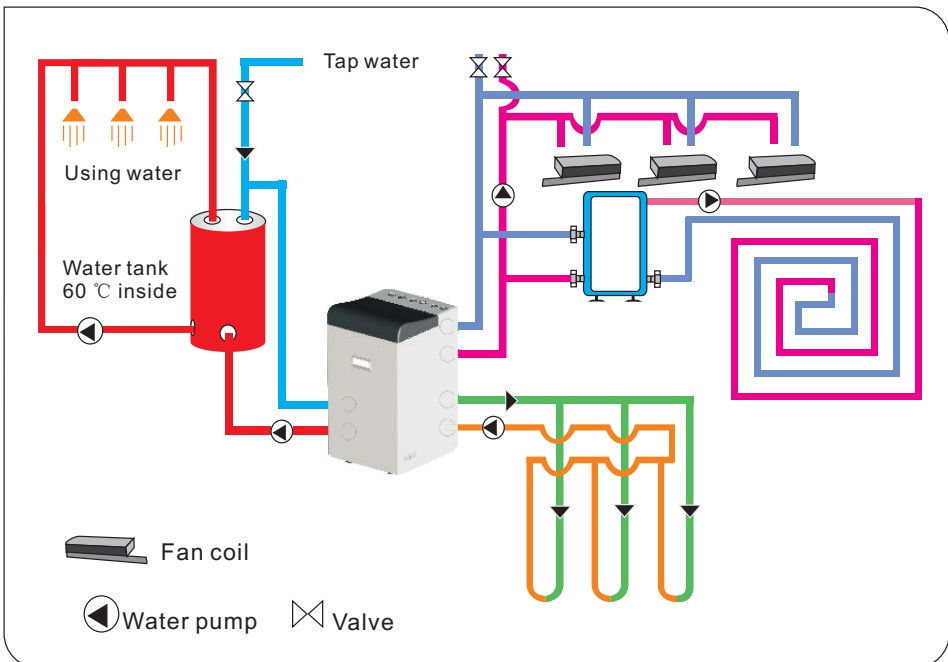

3-Installation and connection

Heat pump & ceiling heating & constant-humidifier & hot water

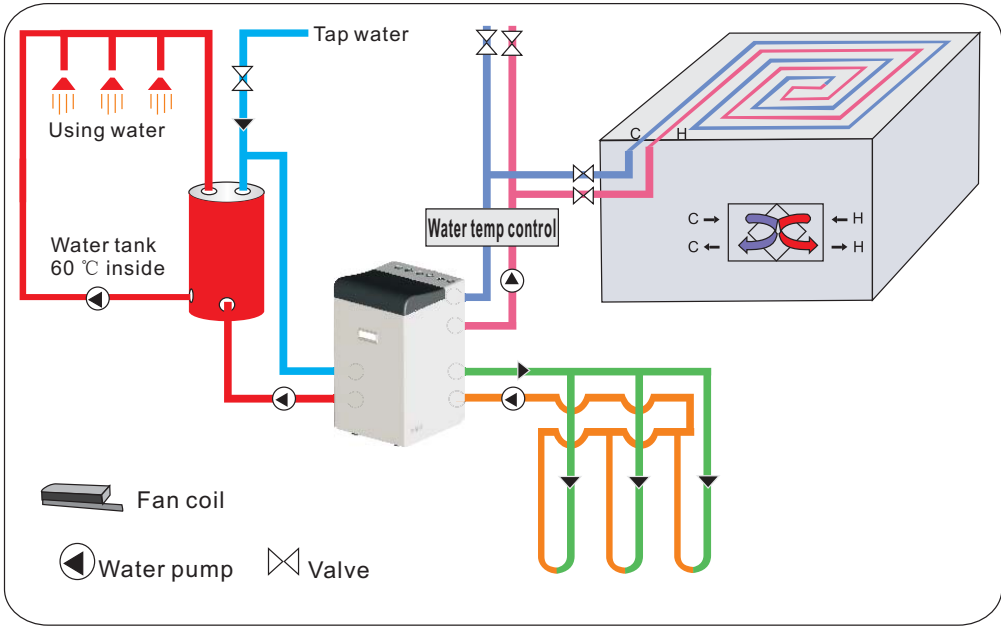

Heat pump & Fan coil & hot water (parallel connection)

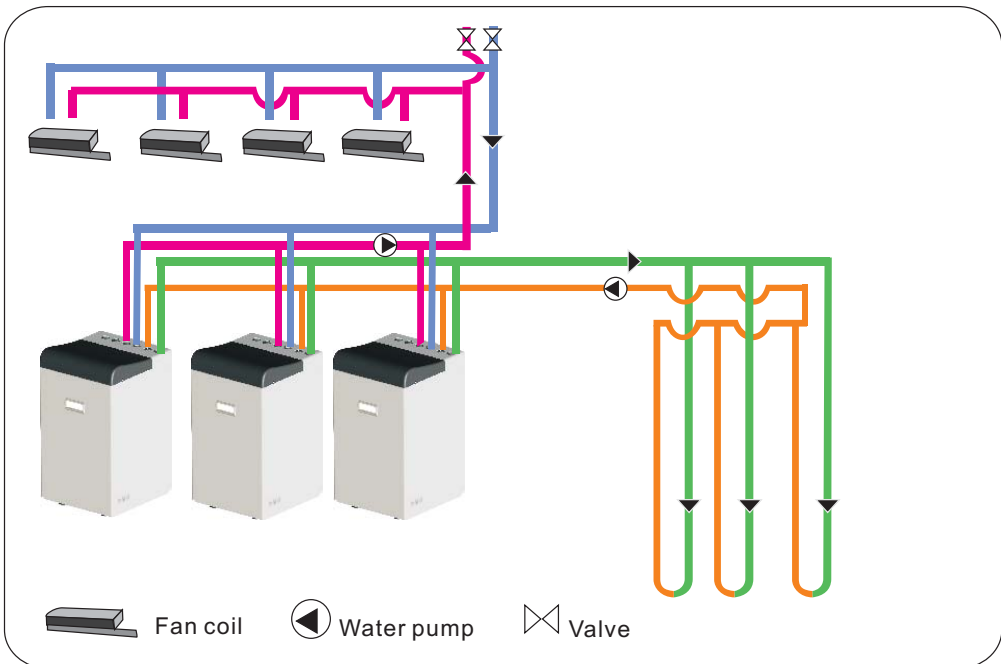

3-Installation and connection

Heat collect system base on the existent air-conditioning system

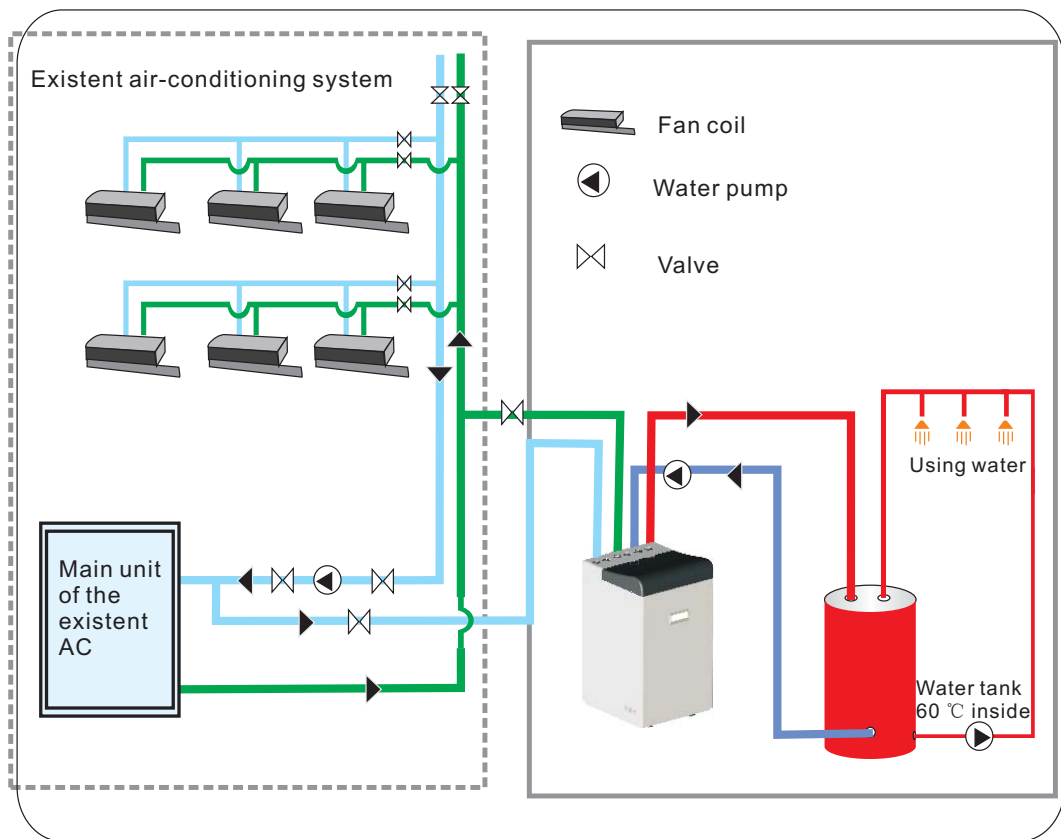

Installation items:

The factory only provides the main unit ; the other items in the illustration are necessary spare parts for the water system ,that provided by users or the installer.

Attention:

Please follow these steps when using for the first time

- 1.Open valve and charge water.
- 2.Make sure that the pump and the water-in pipe have been filled with water.
- 3.Close the valve and start the unit.

3-Installation and connection

Heat pump & ceiling heating & constant-humidifier & hot water

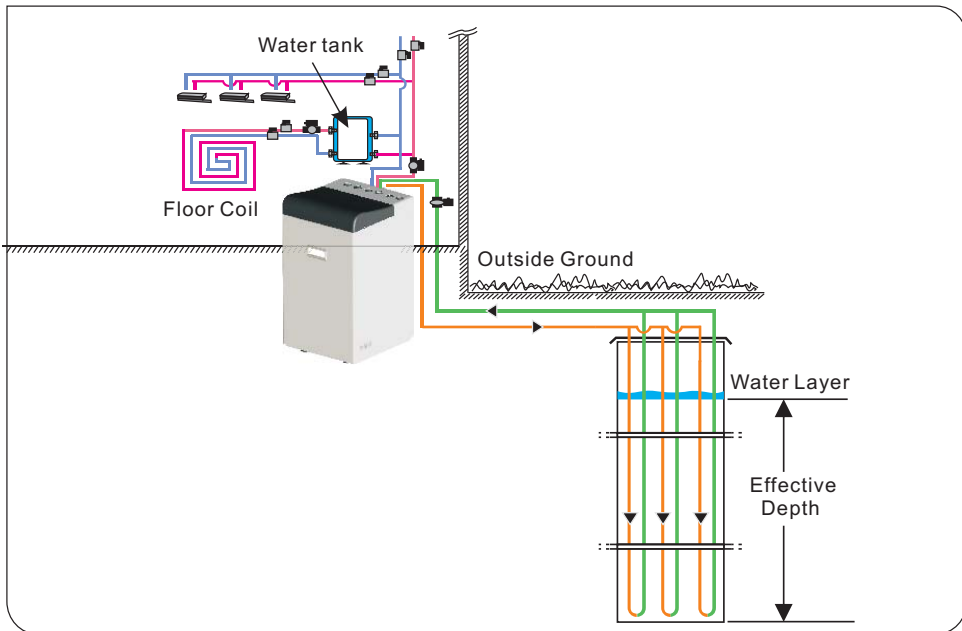

Heat pump & ceiling heating & constant-humidifier & hot water

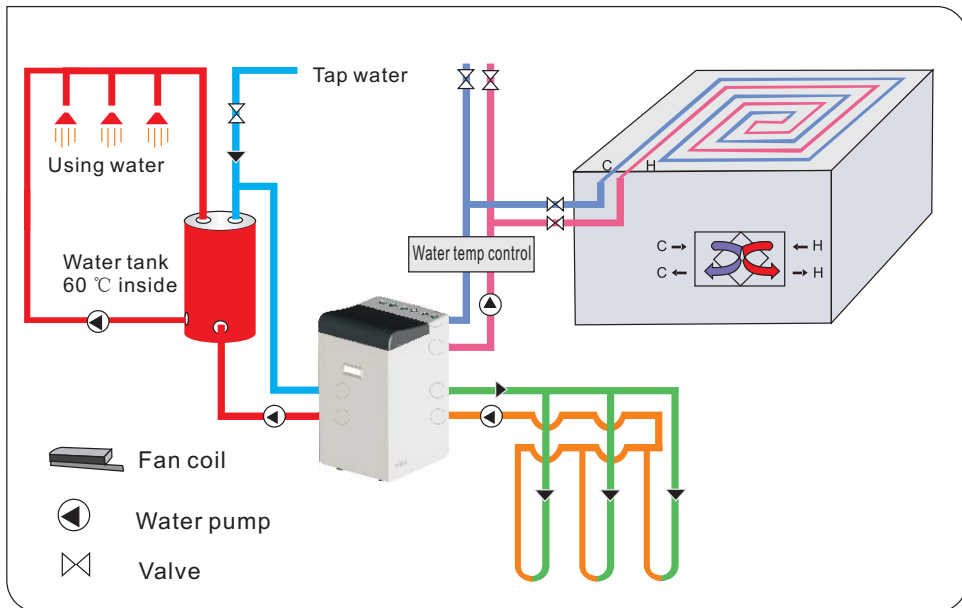

3-Installation and connection

3.2 Heat Pumps Electrical Wiring

NOTE: Although the unit heat exchanger is electrically isolated from the rest of the unit, it simply prevents the flow of electricity to or from the pool water. Grounding the unit is still required to protect you against short circuits inside the unit. Bonding is also required.

The unit has a separate molded-in junction box with a standard electrical conduit nipple already in place. Just open the front panel, feed your supply lines in through the conduit nipple and wire-nut the electric supply wires to the three connections already in the junction box (four connections if three phase). To complete electrical hookup, connect Heat Pump by electrical conduit, UF cable or other suitable means as specified (as permitted by local electrical authorities) to a dedicated AC power supply branch circuit equipped with the proper circuit breaker, disconnect or time delay fuse protection.

Disconnect - A disconnect means (circuit breaker, fused or un-fused switch) should be located within sight of and readily accessible from the unit. This is common practice on commercial and residential air conditioners and heat pumps. It prevents remotely-energizing unattended equipment and permits turning off power at the unit while the unit is being serviced.

3.3 Initial startup of the Unit

NOTE- In order for the unit to start normal work, the circular pump must be running to circulate water through the heat exchanger.

Start up Procedure - After installation is completed, you should follow these steps:

1. Turn on your circular pump. Check for water leaks and verify flow to and from the pool.
2. Turn on the electrical power supply to the unit, then press the key ON/OFF of wire controller. It should start in several seconds.
3. After running a few minutes make sure there is no air inside the pipes.
4. With the unit operating turn the circular pump off. The unit should also turn off automatically.
5. Allow the unit and water pump to run 24 hours per day until desired room temperature is reached. When the water-in temperature reach setting, The unit just shuts off. The unit will now automatically restart (as long as your circular pump is running) when the room temperature drops more than 2°C below set temperature.

Water Flow Switch - the unit is equipped with a flow switch that turns it on when the circular pump is running and shuts it off when the pump shuts off. This switch is the same type used in all heater pumps/chillers and is factory adjusted for normal pool installations.

Time Delay- The unit is equipped with a 3 minute built-in solid state restart delay included to protect control circuit components and to eliminate restart cycling and contactor chatter. This time delay will automatically restart the unit approximately 3 minutes after each control circuit interruption. Even a brief power interruption will activate the solid state 3 minute restart delay and prevent the unit from starting until the 5 minute countdown is completed. Power interruptions during the delay period will have no effect on the 3 minute countdown.

4-Usage and operation

4.1 The displaying of the wire controller

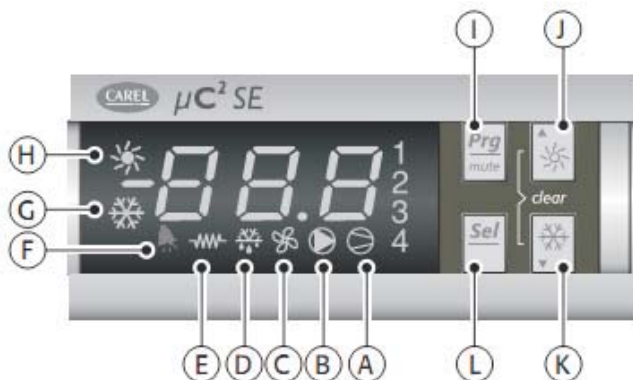

Symbol	Colour	Meaning	
		With LED ON	With LED flashing
1;2	Amber	Compressor 1 and/or 2 ON	Start up request
3;4	Amber	Compressor 3 and/or 4 ON	Start up request
A	Amber	At least one compressor ON	
B	Amber	Pump ON	Start up request
C	Amber	Condenser fan ON	
D	Amber	Defrost active	Defrost request
E	Amber	Heater ON	
F	Red	Alarm active	
G	Amber	Chiller mode	Chiller mode request
H	Amber	Heat pump mode	Heat pump mode request

4-Usage and operation

4.2 Functions associated with the buttons

Button	Unit status	Button press
I	Loading default values	Press at power ON
	Go up a sub-group inside the programming area, until exiting (saving changes to EEPROM)	Press once
	In the event of alarms, mute the buzzer (if present) and deactivate the alarm relay	Press once
L	Access the direct parameters	Press for 5s
	Select item inside the programming area and display value of direct parameters/confirm the changes to the parameters	Press once
I+L	Program parameters after entering password	Press for 5s
J	Select top item inside the programming area	press once or press and hold
	Increase value	press once or press and hold
	Switch from standby to heat pump mode (P6=1) and vice versa	Press for 5s
	Provides immediate access to the condenser and evaporator pressure and temperature probes and DTE, DTC1-2	Press once
K	Select bottom item inside the programming area	press once or press and hold
	Decrease value	press once or press and hold
	Switch from standby to chiller mode (P6=1) and vice versa	Press for 5s
	Provides immediate access to the condenser and evaporator pressure and temperature probes and DTE, DTC1-2	Press once
J+K	Manual alarm reset	Press for 5s
	Immediately reset the hour counter (inside the programming area)	Press for 5s
L+J	Force manual defrost on both circuits	Press for 5s



4-Usage and operation

4.3 Programming and saving the parameters

[1] Start or stop unit

press  or  lasts 3 seconds to start or stop unit the LED display as following 



If you press “  ”, the unit will be heating mode;
If you press “  ”, the unit will be cooling mode;

[2] Check the setting data and amend the setting





1 press  to go into data setting.





2 press  to go into parameter group.





3) use “  ” and “  ” to select the parameter group and then press “  ”.





4) use “  ” and “  ” to select the parameter and then press “  ”.



5) after making the changes to the parameter, press “  ” to confirm or “  ” to cancel the changes.



6) Press “  ” to return to the previous menu to save the modifications, press “  ” repeatedly until reaching the main menu

4-Usage and operation

4.4 Installation of remote controller

(1) Connection

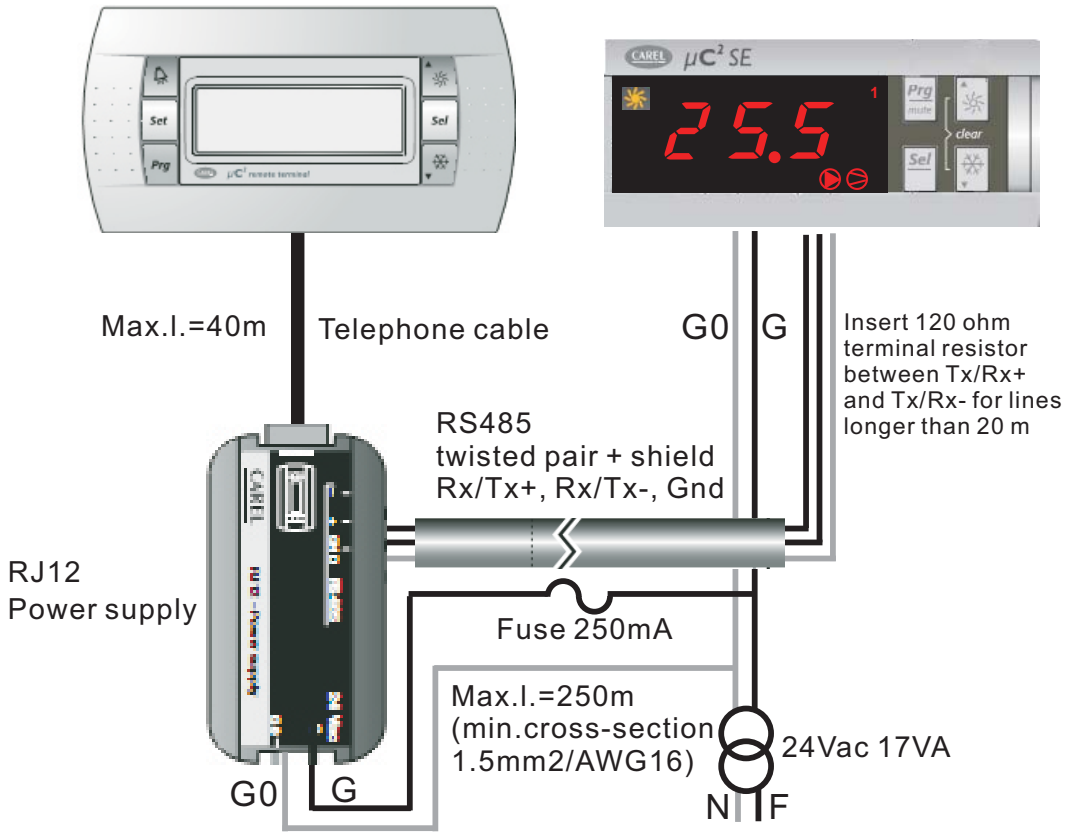

To install the remote terminal, no configuration is required on the UC2, as the terminal works with any serial address set for parameter H10. Check, however, that is fitted with the serial interface the Uc2 FCSE00000. When first switched on the display will show the. firmware version of the Uc2

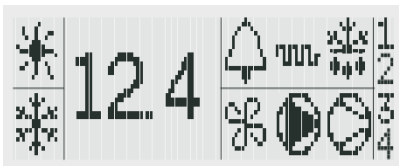

After around 4 s the main screen will be displayed, with the symbols that represent the status of the Uc2.

4-Usage and operation

OFFLINE

In the event where the RS485 connection is not performed correctly or the controller is off, the terminal will clear the display and show the message “OFFLINE”











PGD μCH V1.0
μCH V1.2
μCH Address: 02
Error rate: xx



Pressing the “Up” + “Down” + “Sel” buttons together for more than 6 seconds displays the “INFO” screen containing information on the UC2 system and on the communication.













Pressing the “Prg” button returns to the main screen.

5.3 Symbol meaning

Symbol	Meaning		Refrigerant circuit involved
	ON	Flashing	
1,2	Compressor 1 and/or 2 ON	Start request	1
3,4	Compressor 3 and/or 4 ON	Start request	2
	At least one compressor ON		1 and/or 2
	Pump ON	Start request	1 and/or 2
	Condenser fan ON	Start request	1 and/or 2
	Defrost active	defrost request	1 and/or 2
	Heater ON	Start request	1 and/or 2
Alarm button red LED	Alarm active		1 and/or 2
	Alarm active	EEPROM alarm	1 and/or 2
	Warning relay activated		
	Alarm relay active		
	Chiller mode (P6=1)	Season changeover reques	1 and 2
	Heat pump mode (P6=1)	Season changeover reques	1 and 2

4-Usage and operation

4.5 Functions associated with the buttons

Button	Unit status	Button operation
	Switch off buzzer or alarm relay, if alarm active	Press once
	Manual reset of alarms that are no longer active	Press for 5 s
	Enter parameter programming mode after entering password	Press once
	Return to higher subgroup inside the programming environment until exiting, saving to EEPROM	Press once
	Select higher item inside the programming environment	Press once or hold
	Switch from standby to heat pump mode (P6= 1) and vice-versa	Press for 5 s
	Access direct parameters:selection (as for button on Uc2)	Press for 5 s
	Select item inside the programming environment and display direct parameter values/confirm the changes to the parameter	Press once
	Select lower item inside the programming environment	Press once or hold
	Switch from standby to chiller mode (P6= 1) and vice-versa	Press for 5 s
 + 	Immediately reset the hour counter (inside the programming environment)	Press for 5 s
 + 	Start manual defrost on both circuits	Press for 5 s
 +  + 	Display the terminal Info screen	Press for 6 s

5-Maintenance and Service

1. Maintenance

- Check the water supply and air vent frequently, to avoid lack of water or air in the water loop. Clean the water filter in a certain period to keep good water quality. Lack of water and dirty water can damage the unit. The heat pump will start the water pump per 72 hours when it is not running, to avoid freezing.
 - Keep the unit in a place which is dry and clean, and has good ventilation. Clean the heat exchanger in 1 or 2 month and keep good heat exchange rate and save energy.
 - Check each part of the unit and the pressure of the system. Replace the failure part if there is any, and recharge the refrigerant if it is needed.
 - Check the power supply and the electrical system, make sure the electrical components are good, the wiring is well. If there is any part failed with wrong action or smell, please replace in time.
 - If the heat pump is not used for a long time, please drain out all the water in the unit and seal the unit to keep it good. Please drain the water from the lowest point of the heat exchanger to avoid freezing in winter. Water recharge and full inspection on the heat pump is needed before it is restarted.
 - Please drain out the water in the super heater of the heat pump unit in winter, when the super heater is not used.
 - The water loop of the heat pump MUST be protected from freezing in winter time. Please pay attention to below suggestions. Nonobservance on below suggestion will invalid the warranty for the heat pump.
- (1) Please do not shut off the power supply to the heat pump in winter. When the air temperature is below 0 °C, if the inlet water temperature is above 2 °C and below 4°C, the water pump will start for freezing protect, if the inlet water is lower than 2 °C, the heat pump will run for heating.
- (2) Use anti-freezing liquid (glycol water)
- Anti-freeze liquid (like glycol) must be filled into the cooling water system to avoid freezing in the area with cold climate;
 - Volume of the glycol in different unit(see below table):

Liquor consistence %	Weight	5	10	15	20	25	30	35	40
	Volume	4.4	8.9	13.6	18.1	22.9	27.7	32.6	37.5
Freezing °C		-1.4	-3.2	-5.4	-7.8	-10.7	-14.1	-17.9	-22.3

- As for how to add anti-freeze liquid(like glycol), please refer to the Users Manual.

Note: if the glycol water is too much, the water flow and water pump will be influenced and the heat exchange rate will be decreased. This table is for reference, please use anti-freezing water according to the real condition of the local climate.

5-Maintenance and Service

2. Look over and clear the failure according to below information.

Failure	Possible causes for the failure	Solutions
Heat pump cannot be started	<ol style="list-style-type: none"> 1 Wrong power supply 2 power supply cable loose 3 circuit breaker open 	<ol style="list-style-type: none"> 1 shut off the power and check power supply; 2 check power cable and make right connection 3 check for the cause and replace the fuse or circuit breaker
Water pump is running with high noise or without water	<ol style="list-style-type: none"> 1 lack of water in the piping 2 much air in the water loop 3 water valves closed 4 dirt and block on the water filter 	<ol style="list-style-type: none"> 1 check the water supply and charge water to the piping; 2 discharge the air in the water loop; 3 open the valves in water loop; 4 clean the water filter.
Heat pump capacity is low, compressor do not stop	<ol style="list-style-type: none"> 1 lack of refrigerant; 2 bad insulation on water pipe; 3 low heat exchange rate on air side exchanger; 4 lack of water flow 	<ol style="list-style-type: none"> 1 check for the gas leakage and recharge the refrigerant; 2 make good insulation on water pipe; 3 clean the air side heat exchanger; 4 clean the water filter
High compressor exhaust	<ol style="list-style-type: none"> 1 too much refrigerant 2 low heat exchange rate on air side exchanger 	<ol style="list-style-type: none"> 1 discharge the redundant gas 2 clean the air side heat exchanger
Low pressure problem of the system	<ol style="list-style-type: none"> 1 lack of gas 2 block on filter or capillary 3 lack of water flow 	<ol style="list-style-type: none"> 1 check the gas leakage and recharge freon; 2 replace filter or capillary; 3 clean the water filter and discharge the air in water loop.
Compressor do not run	<ol style="list-style-type: none"> 1 power supply failure 2 compressor contactor broken 3 power cable loose 4 protection on compressor 5 wrong setting on return water temp. 6 lack of water flow 	<ol style="list-style-type: none"> 1 check off the power supply; 2 replace compressor contactor; 3 tighten the power cable; 4 check the compressor exhaust temp.; 5 reset the return water temp.; 6 clean the water filter and discharge the air in water loop.
High noise of compressor	<ol style="list-style-type: none"> 1 liquid refrigerant goes into compressor 2 compressor failure 	<ol style="list-style-type: none"> 1 bad evaporation, check the cause for bad evaporation and get rid of this; 2 use new compressor;
Fan do not run	<ol style="list-style-type: none"> 1 failure on fan relay 2 fan motor broken 	<ol style="list-style-type: none"> 1 replace the fan relay; 2 replace fan motor.
The compressor runs but heat pump has not heating or cooling capacity	<ol style="list-style-type: none"> 1 no gas in the heat pump; 2 heat exchanger broken; 3 compressor failure. 	<ol style="list-style-type: none"> 1 check system leakage and recharge refrigerant; 2 find out the cause and replace the heat exchanger; 3 replace compressor.
Low outlet water temperature	<ol style="list-style-type: none"> 1 low water flow rate; 2 low setting for the desired water temp.; 	<ol style="list-style-type: none"> 1 clean the water filter and discharge the air in water loop. 2 reset the desired water temperature.
Low water flow protection	<ol style="list-style-type: none"> 1 lack of water in the system; 2 failure on flow switch 	<ol style="list-style-type: none"> 1 clean the water filter and discharge the air in water loop. 2 replace the flow switch.

6-Excursus

Excursus1 The unit's parameter

Please set according the below table:

<i>Par</i>	<i>Description</i>	<i>Limits</i>	<i>Unit</i>
<i>R01</i>	<i>Cooling set-point</i>	12	°C
<i>R02</i>	<i>Cooling differential</i>	2	°C
<i>R03</i>	<i>Heating set-point</i>	40	°C
<i>R04</i>	<i>Heating differential</i>	2	°C

6-Excursus

Excursus 2 Compensate temperature chart

When the parameter set :

R01=20 R02=2 R03=30 R04=2

R17=-0.5 R18=20 R19=15 R20=20 R31=-0.8,

The compensate graphs in the heating and cooling mode are as follows:

Heating mode:

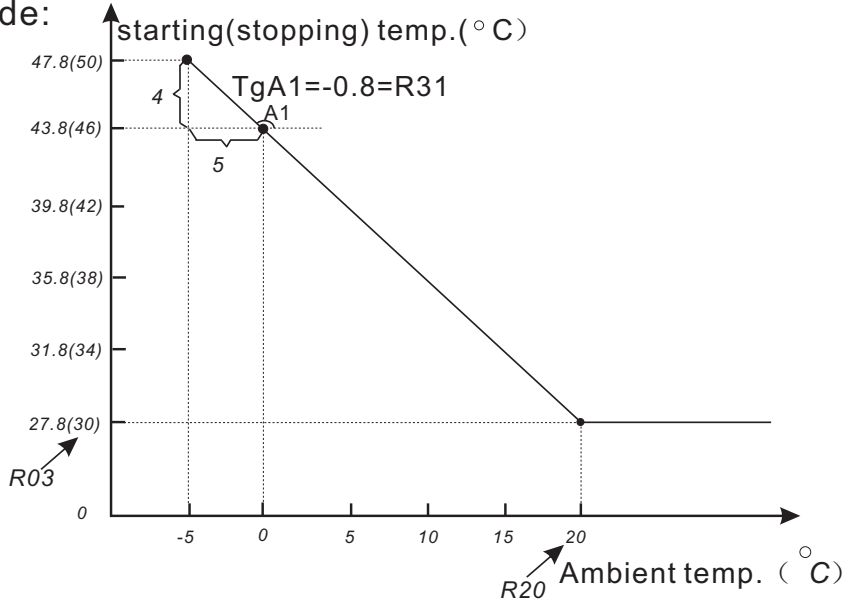

Cooling mode:

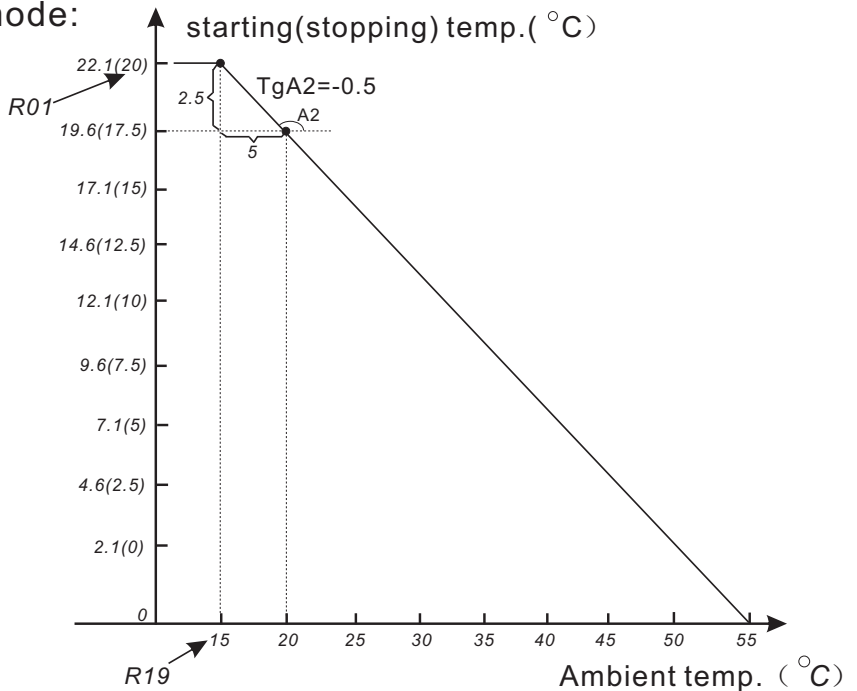

7-Appendix

7.1 Connection of PCB illustration

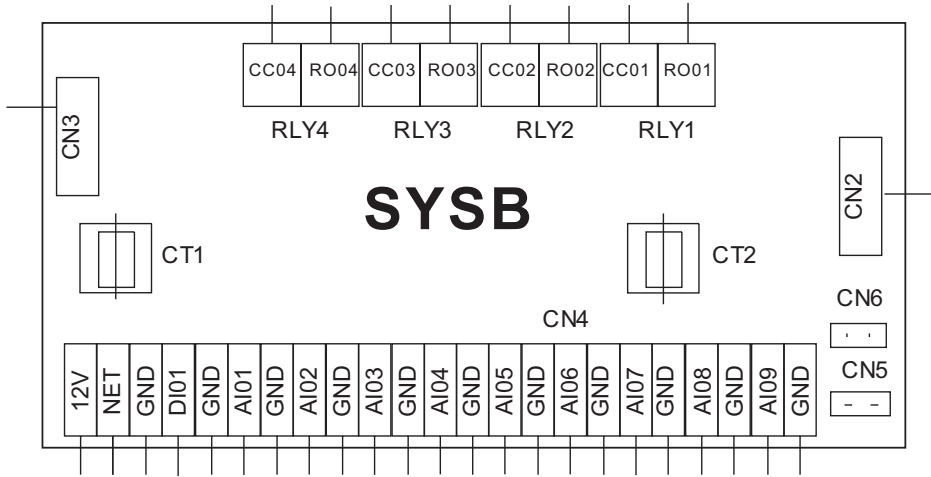

Connections explanation:

No.	Symbol	Meaning
1	RO01	System1 mangtic valve outlet (220-230VAC)
2	RO02	System2 mangtic valve outlet (220-230VAC)
3	RO03	System1 alert outlet (220-230VAC)
4	RO04	System2 alert outlet (220-230VAC)
5	CC01	System1 mangtic valve inlet (220-230VAC)
6	CC02	System2 mangtic valve inlet (220-230VAC)
7	CC03	System1 alert inlet (220-230VAC)
8	CC04	System2 alert inlet (220-230VAC)
9	NET GND 12V	Wire controller
10	DI01 GND	Mode/communication
11	AI01 GND	System 1 anti-freeze temp.(input)
12	AI02 GND	System 2 anti-freeze temp.(input)
13	AI03 GND	System 1 economizer inlet temp.failure(input)
14	AI04 GND	System 1 economizer outlet temp.failure(input)
15	AI05 GND	System 2 economizer inlet temp.failure(input)
16	AI06 GND	System 2 economizer outlet temp.failure(input)
17	AI07 GND	System 1 exhaust temp.(input)
18	AI08 GND	System 2 exhaust temp.(input)
19	AI09 GND	Ambient temp.(input)

7-Appendix

2.SYSB malfunction Table

The common failure cause and solution.

Malfunction	Display	Causes	Solution
System 1 exhaust temp.failure	P181	The sensor is open or short circuit	Check or change the sensor
System 2 exhaust temp.failure	P281	The sensor is open or short circuit	Check or change the sensor
Ambient temp.sensor failure	P04	The sensor is open or short circuit	Check or change the sensor
System 1 anti-freeze temp.failure	E171	The sensor is open or short circuit	Check or change the sensor
System 2 anti-freeze temp.failure	E271	The sensor is open or short circuit	Check or change the sensor
System 1 economizer inlet temp.failure	P101	The sensor is open or short circuit	Check or change the sensor
System 2 economizer inlet temp.failure	P201	The sensor is open or short circuit	Check or change the sensor
System 1 economizer outlet temp.failure	P102	The sensor is open or short circuit	Check or change the sensor
System 2 economizer outlet temp.failure	P202	The sensor is open or short circuit	Check or change the sensor
System 1 anti-freeze protection	P19	Water flow volume not enough	Check the flow volume,water system is jammed or not
System 2 anti-freeze protection	P29	Water flow volume not enough	Check the flow volume,water system is jammed or not
Communication failure	E08	Communication failure between remote wire controller and main board	Check the wire connection between remote wire controller and main board
System 1 current protection	E151	Current through compressor too heavy	Check through the power supply for compressor or short circuit
System 2 current protection	E251	Current through compressor too heavy	Check through the power supply for compressor or short circuit
System 1 exhaust high temp.protection	P182	Compressor exhaust temp.too high	Check through the refrigerant system
System 2 exhaust high temp.protection	P282	Compressor exhaust temp.too high	Check through the refrigerant system

7-Appendix

The unit can only be repaired by qualified personnel or an authorised dealer.

This appliance is not intended for use by persons (including children) with reduced physical sensory or mental capabilities, or lack of experience and knowledge, unless they have been given supervision or instruction concerning use of the appliance by a person responsible for their safety.

Children should be supervised to ensure that they do not play with the appliance.

Please make sure that the unit and power connection have good earthing, otherwise there is a risk of electrical shock.

If the supply cord is damaged, it must be replaced by the manufacturer, our service agent or a similarly qualified person in order to avoid a hazard.

Directive 2002/96/EC (WEEE):

The symbol depicting a crossed-out waste bin that is underneath the appliance indicates that this product at the end of its useful life, must be handled separately from domestic waste, and must be taken to a recycling centre for electric and electronic devices or handed back to the dealer when purchasing an equivalent appliance.

Directive 2002/95/EC (RoHs): This product is compliant with directive 2002/95/EC (RoHs) concerning restrictions for the use of harmful substances in electric and electronic devices.

The unit CANNOT be installed near flammable gas. If there is any leakage of the gas a fire can occur.

Make sure that there is circuit breaker for the unit, lack of circuit breaker can lead to electrical shock or fire.

The heat pump located inside the unit is equipped with an over-load protection system. It does not allow for the unit to start for at least 3 minutes from a previous stoppage.

The unit can only be repaired by the qualified personnel of an installer center or an authorized dealer.

Installation must be performed in accordance with the NEC/CEC by authorized person only (for North America market)

USE SUPPLY WIRES SUITABLE FOR 75°C.

Caution: Single wall heat exchanger, not suitable for potable water connection.

7-Appendix

7.3 Cable specification

1. Single phase unit

Nameplate maximum current	Phase line	Earth line	MCB	Creepage protector	Signal line
No more than 13A	2×1.5mm ²	1.5mm ²	20A	30mA less than 0.1 sec	n×0.5mm ²
13~25A	2×4mm ²	4mm ²	40A	30mA less than 0.1 sec	
25~30A	2×6mm ²	6mm ²	40A	30mA less than 0.1 sec	
30~40A	2×10mm ²	10mm ²	63A	30mA less than 0.1 sec	
40~55A	2×16mm ²	16mm ²	80A	30mA less than 0.1 sec	
55~70A	2×25mm ²	25mm ²	100A	30mA less than 0.1 sec	

2. Three phase unit

Nameplate maximum current	Phase line	Neutral line	Earth line	MCB	Creepage protector	Signal line
No more than 13A	3×1.5mm ²	1.5mm ²	1.5mm ²	20A	30mA less than 0.1 sec	n×0.5mm ²
13~25A	3×4mm ²	4mm ²	4mm ²	40A	30mA less than 0.1 sec	
25~30A	3×6mm ²	4mm ²	6mm ²	40A	30mA less than 0.1 sec	
30~40A	3×10mm ²	4mm ²	10mm ²	63A	30mA less than 0.1 sec	
40~55A	3×16mm ²	4mm ²	16mm ²	80A	30mA less than 0.1 sec	
55~70A	3×25mm ²	4mm ²	25mm ²	100A	30mA less than 0.1 sec	

When the unit will be installed at outdoor, please use the cable which can against UV.