



EVO COMFORT MANUAL



Installation & Operation

**Read this manual carefully before
installing or operating this unit**

Contents

1. Preface	3
2. Information on the Evo Comfort	4
2.1 Evo Comfort Technology	4
2.2 Running Range	4
2.3 Functions	5
2.4 Heat Pump Protection	5
2.5 Specification Data	6
2.6 Unit Dimensions	7
3. Safety Precautions	11
4. Installation	13
4.1 Transit	13
4.2 Installation Notes.....	13
4.3 Water Loop Connection.....	14
4.4 Location of the Unit	15
4.5 Water Connection Diagram	16
4.6 Power Supply Connection.....	16
4.7 Cable and Switches	17
4.8 Inspection Before Trial Operation	18
4.9 Trial Operation.....	18
5. Controlling and Operation	19
5.1 Main Interface Display and Function.....	19
5.1.1 Power On Screen	19
5.1.2 Start Up Screen.....	19
5.2 Wire Controller Usage	21
5.2.1 On and Off	21
5.2.2 Mode Switch	21
5.2.3 Setting Target Temperature	22
5.2.4 Fast Heating	23
5.2.5 Timer Setting	23
5.2.6 Fault Interface	24
5.2.7 Colour Display Calibration	24
6. Troubleshooting.....	25
6.1 Maintenance.....	25
6.2 Malfunction Table.....	26
6.3 Parameter List.....	27
7. Main Controller Terminals.....	28
7.1 Wire Control Interface Diagram and Definition	28
7.2 The Main Controller Terminals.....	28
7.3 Connection of PCB Illustration.....	30
7.4 Common Observations	31
8. Appendix	32
8.1 Caution & Warnings.....	32
8.2 Cable Specifications	33



1. Preface

This manual includes all the necessary information in regard to installation, debugging, discharging and maintenance of your unit. Ensure the contents of this manual are read carefully before the unit is opened or maintained.

Read these operation and installation instructions carefully. Positioning, installation and commissioning must be carried out by trained personnel working in accordance with these instructions.

If the heat pump is to be installed at a later time, keep it free from damage, rust and abrasion by using the following methods:

- All access points such as water connections must be sealed correctly
- The unit must be free from sun exposure, and kept in temperatures of under 45°
- Ensure a dust build up does not occur on the unit to avoid dirt reaching the evaporator

It is vital that all instructions are adhered to at all times to keep the warranty. The unit can only be installed or repaired by a qualified installer and authorised dealer. Maintenance and operation should be carried out according to the recommended frequency. Only genuine standard spare parts must be used. Pictures and drawings in this manual are for your information only. The manufacturer has the right to change or improve the product when required, without prior notification to the users of this device.



2. Information on the Evo Comfort

2.1 Evo Comfort Technology

The Evo Comfort extracts heat from ambient air and transfers it to water. By circulating the water, the energy is used to warm the house efficiently. Compared with oil boilers, gas boilers, and electrical heaters, the heat pump is the best solution by providing high efficiency, safety, and environmental protection.

The Evo Comfort is ideal for luxury domestic and commercial applications that require space heating and cooling and hot water, offering a unique high efficiency solution to heating, cooling and hot water using the one heat pump.

The Evo Comfort provides hot water up to 65°C and by combining EVI Technology, features a wide operating temperature range with stable running performance - even in cold climates. Using Wet Injection Technology allows the Evo Comfort to work safely with reliability at ambient temperatures as low as -30°C.

ECO FRIENDLY



HIGHLY EFFICIENT AND MONEY SAVING



SAFE TO USE AND LONG UNIT LIFE



EASY OPERATION



2.2 Running Range

Evo Comfort 19 / 37 / 50 / 100

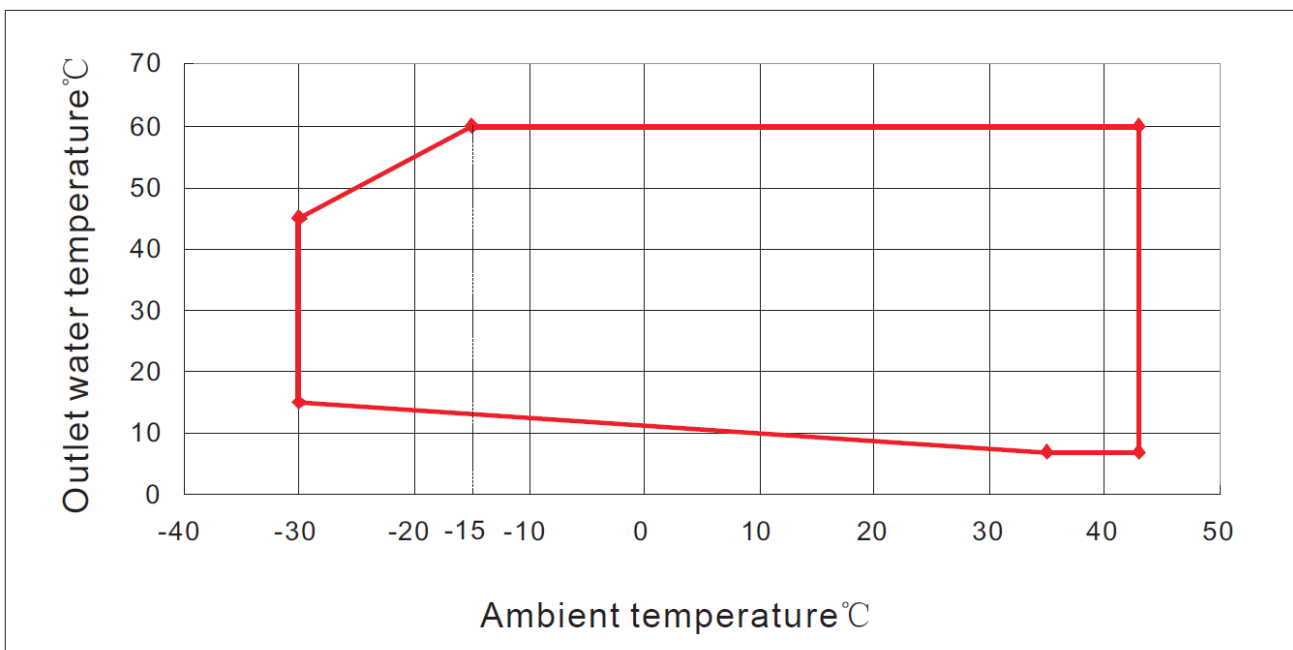

Running Ambient Temperature Comparison

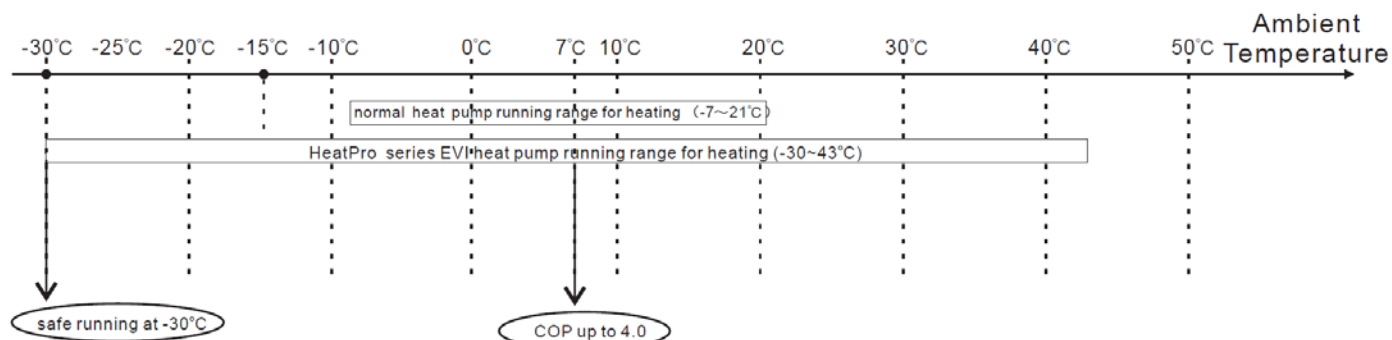

2.3 Functions

- Heating/Cooling
- Smart Defrost
- Auto Protection
- Multiple Module Control
- Automatic Reset for Partial Failure
- Auto Alert
- Remote Control

2.4 Heat Pump Protection

- Water flow protection
- Compressor overload, discharge air temp protection
- Discharge air pressure over high protection
- Suction air pressure over low protection
- Water (out) temperature over high protection
- Water (out) temperature over low protection
- Suspend anti-freezing protection in winter
- Compressor frequent switching protection

2.5 Specification Data

Evo Comfort Model		19	37	50	100
*Heating Capacity	kW	19.0	36.5	50	100
	kcal/h	16337	31384	42992	85984
**Heating Capacity	kW	15.9	31.4	43	86.0
	kcal/h	13672	26999	36973	73947
***Heating Capacity	kW	15.7	31.1	42	84.0
	kcal/h	13500	26741	36114	72227
Cooling Capacity	kW	11.5	18.0	27.3	59.0
	kcal/h	9888	15477	23473	46948
*Power Input for Heating	kW	4.1	7.8	10.8	22.0
**Power Input for Heating	kW	5.3	10.6	14.5	29.0
***Power Input for Heating	kW	3.47	7.4	10	20.0
Power Input for Cooling	kW	4.0	7.5	10.6	21.9
Running Current (*Heating/**Heating/ ***Heating/Cooling)	A	7.1/8.2/6.0/6.9	13.5/18.4/12.8/13.0	19.2/25.8/17.8/18.8	46.7/61.5/42.4/46.5
Power Supply		380-415V/3N~/50Hz	380-415V/3N~/50Hz	380-415V/3N~/50Hz	380-415V/3N~/50Hz
Compressor Quantity		1	2	1	2
Compressor Type		EVIScroll	EVIScroll	EVIScroll	EVIScroll
Fan Quantity		2	2	1	2
Fan Power Input	W	140x2	300x2	1100x1	1100x2
Fan Rotate Speed	RPM	850	875	900	900
Noise	dB(A)	60	65	68	73
Water Connection	inch	1	1.5	1.5	DN80 Flange
Water Flow Rate	M ³ /h	2.6	5.2	8.5	17
Water Pressure Drop	kPa	60	53	60	65
Unit Dimension (L/W/H)	mm	(Subject to drawings of the heat pump)			
Packing Size (L/W/H)	mm	(Subject to data on the package)			
Net Weight	kg	(Subject to data on the nameplate)			
Gross Weight	kg	(Subject to data on the package)			

1. *Hot Water: outdoor temperature DB/WB20°C/15°C , outlet water circulation from 15°C to 55°C;
2. **Heating: outdoor temperature DB/WB7°C/6°C , outlet water 55°C, inlet water (return) 50°C;
3. ***Heating: outdoor temperature DB/WB7°C/6°C , outlet water 35°C, inlet water (return) 30°C;
4. Cooling: outdoor temperature DB/WB35°C/24°C , outlet water 7°C, inlet water (return) 12°C.



2.6 Unit Dimensions

Evo Comfort 19

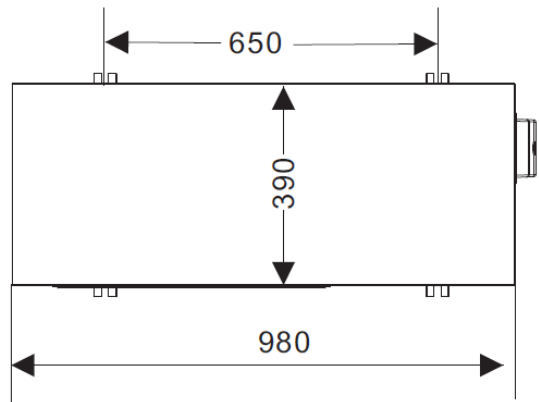
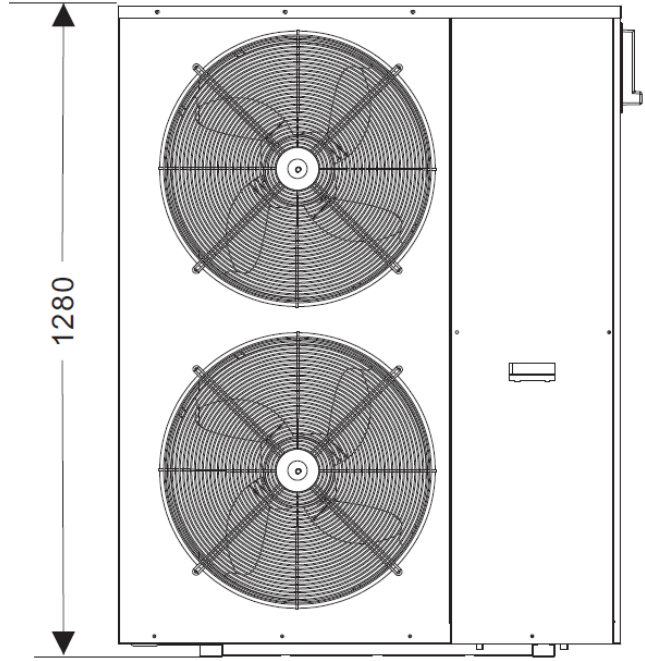
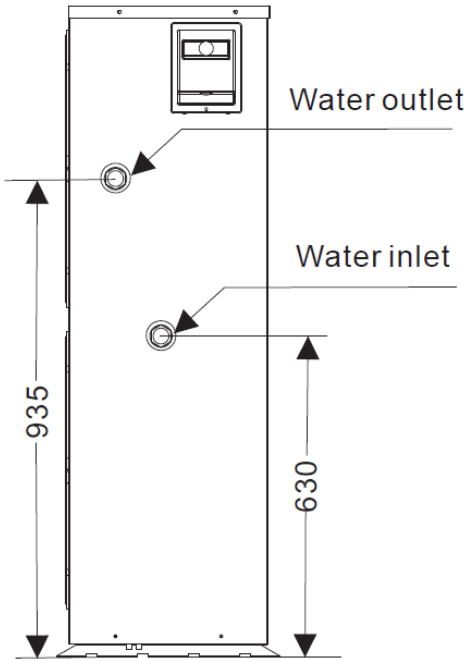

Evo Comfort 37

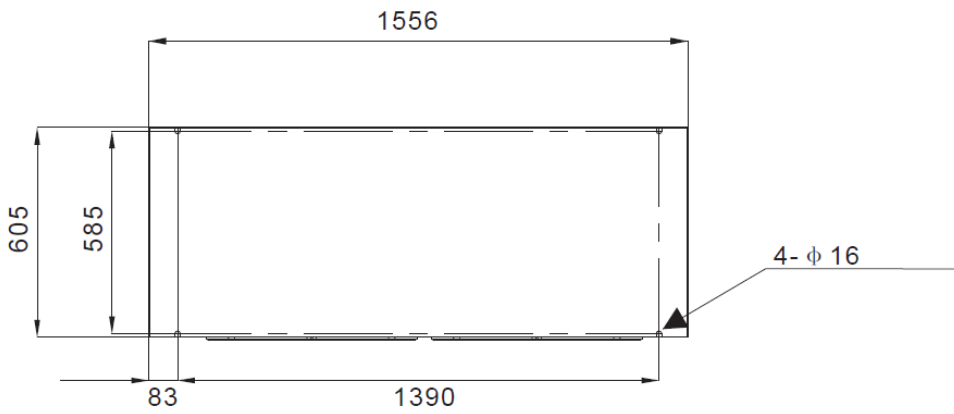
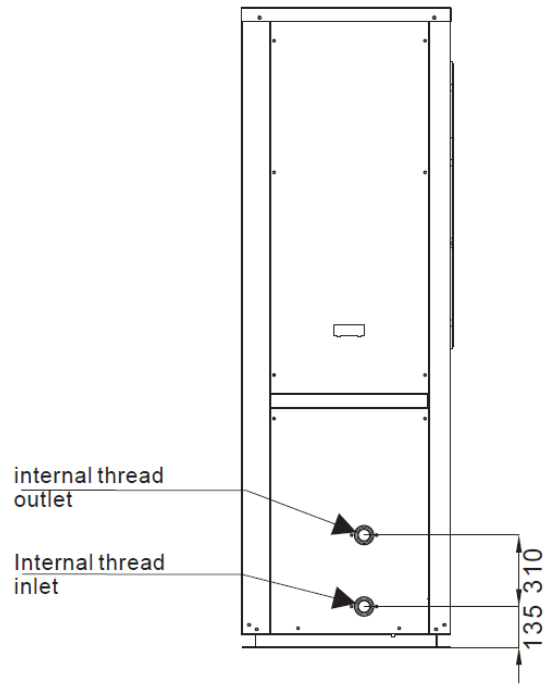
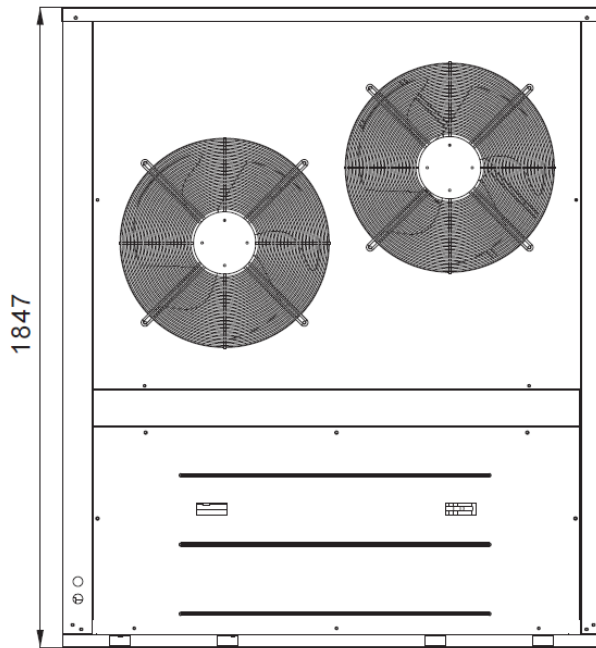

Evo Comfort 50

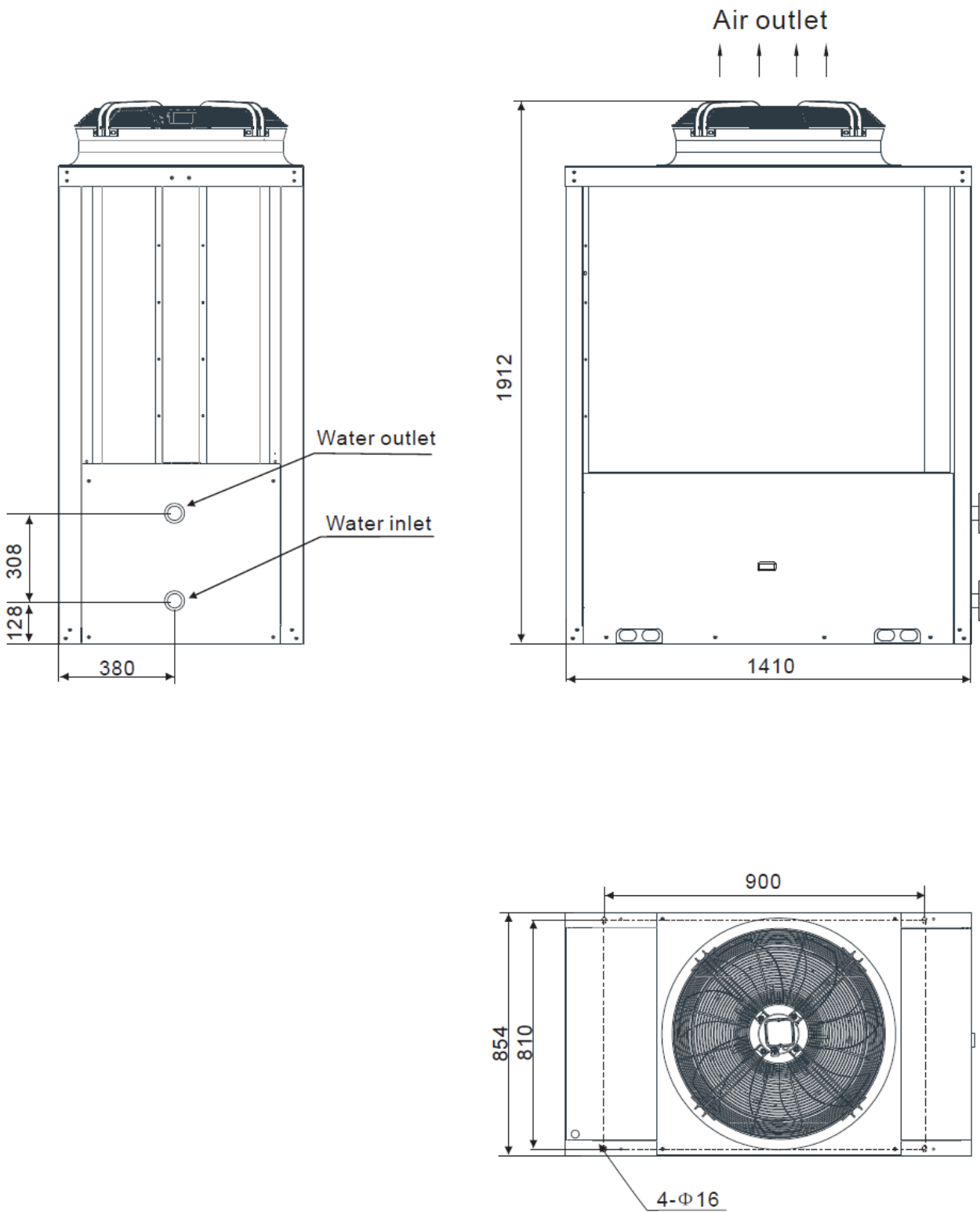

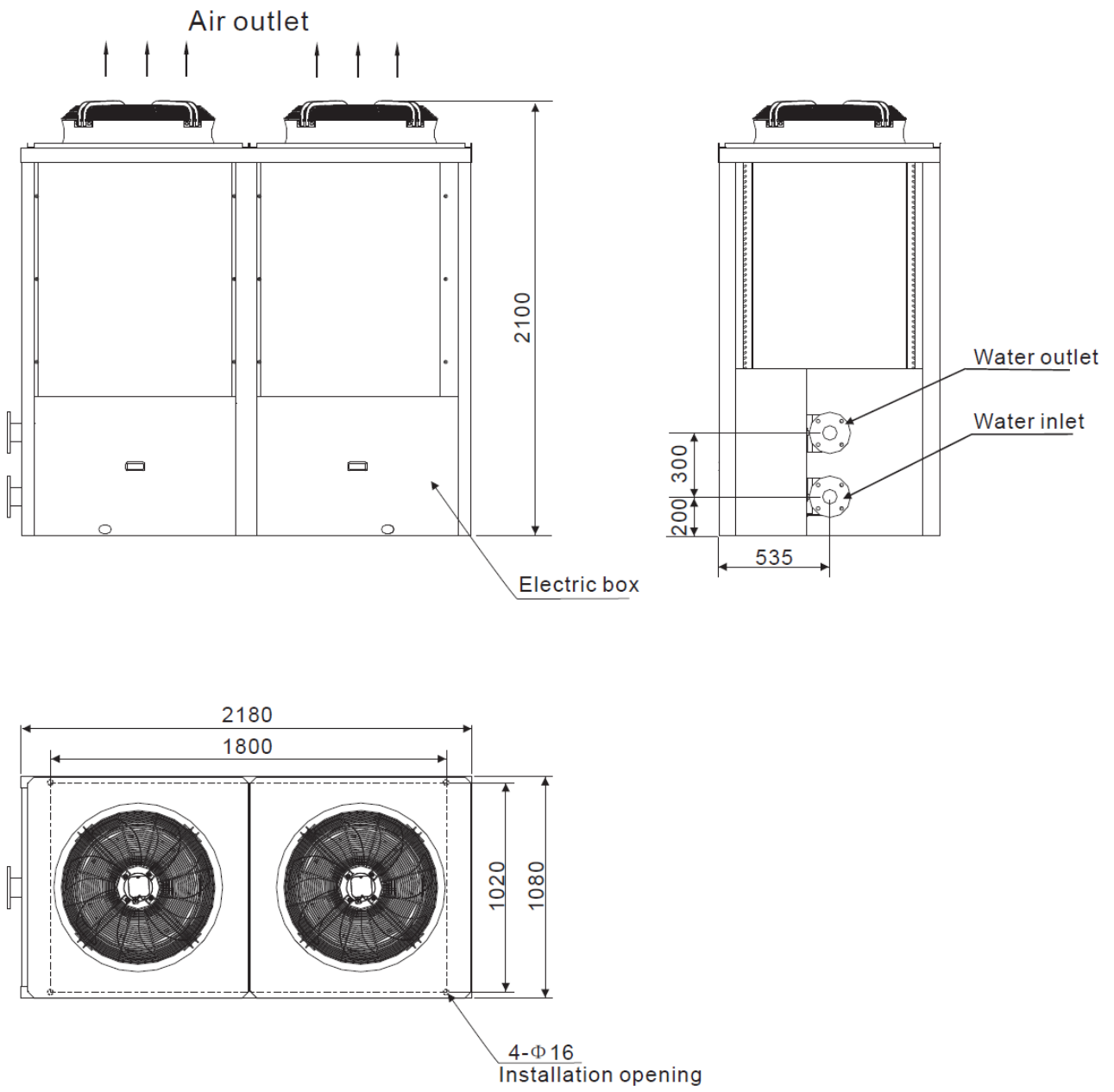

Evo Comfort 100











3. Safety Precautions







To prevent personal injury and avoid causing damage to the unit, be sure to read the information documented below.



The piping connection and wiring should be installed according to the local legislation and regulations as well as the professional standard.

Mark	Meaning
 WARNING	Wrong operation may lead to death or fatal injury on people.
 ATTENTION	Wrong operation may lead to harm on people of loss of life.

Icon	Meaning
	Prohibition. What is prohibited will be nearby this icon.
	Compulsory implement. The listed action needs to be taken.
	ATTENTION (including WARNING) Please pay attention to what is indicated

Installation	Meaning
 Professional installer is required	The heat pump must be installed by qualified personnel to avoid improper installation which can lead to water leakage, electrical shock or fire.
 Earthing is required	Please make sure that the unit and power connection have good earthing, otherwise this may cause electrical shock.
 Installation Place	The unit CANNOT be installed near a flammable gas. Once there is any leakage of the gas, fire can occur.
 Fix the unit	Make sure that the basement of the heat pump is strong enough to avoid any falling down of the unit.
 Need circuit breaker	Make sure that there is circuit breaker for the unit, lack of circuit breaker can lead to electrical shock or fire.

Operation	Meaning
 PROHIBITION	DO NOT put fingers or objects into the fans and evaporator of the unit, otherwise harm may occur.
 Shut off the power	When there is something wrong or a strange smell, the power supply needs to be shut off to stop the unit. Continuing to run may cause electrical shortage or fire.
 Check the installation basement	Please check the installation basement periodically (monthly), to avoid any damage on the basement, which may hurt people or damage the unit
 Shut off the power	Please switch off the power for cleaning or maintenance.
 Prohibition	It is prohibited to use copper or iron as fuse. The right fuse must be fixed by an electrician for the heat pump.
 Prohibition	It is prohibited to spray flammable gas near the heat pump as it may cause fire.

Move and Repair	Meaning
 Entrust	When the heat pump needs to be moved or installed again, please entrust the dealer or qualified person to carry it out. Improper installation will lead to water leakage, electrical shock, injury or fire.
 Entrust	When the heat pump needs to be repaired, entrust the dealer or a qualified person to carry it out. Improper movement or repair on the unit will lead to water leakage, electrical shock, injury or fire.
 Prohibit	It is prohibited to repair the unit by the user himself, otherwise electrical shock or fire may occur.

4. Installation

4.1 Transit

When the heat pump is to be transported, please keep the unit standing upright. The unit cannot be laid down, otherwise inner parts of the device may become damaged.



If the unit needs to be hung up during installation an 8 metre cable will be needed to do so. There must be padding of some kind between the cable and the unit to prevent damage to the heat pump cabinet.

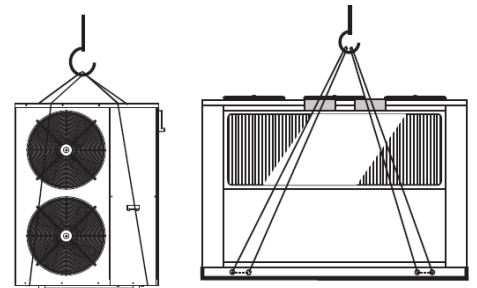

DO NOT TOUCH THE RADIATING FINS BEHIND THE MACHINE WITH HANDS OR OBJECTS!

4.2 Installation Notes

- The unit can be installed in any outdoor area which can carry heavy machinery, such as a terrace, rooftop, the ground etc.
- The location must have adequate ventilation and be free from strong winds.
- The installation location must be free from heat radiation and fire hazards.
- Ensure there are no obstacles near the air inlet and outlet of the heat pump.
- There must be a water channel around the heat pump to drain condensing water.
- Ensure that there is enough space around the unit for maintenance.
- The heat pump can be installed onto the concrete basement using expansion screws, or onto a steel frame with rubber feet which can be placed on the ground or rooftop. Ensure the unit is placed horizontally.

A snow shelter is required in areas that receive snow:

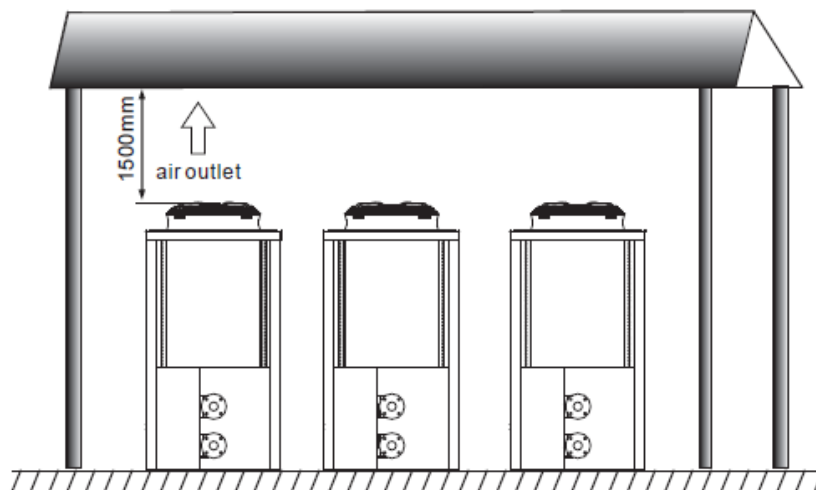

4.3 Water Loop Connection

- Try to reduce the resistance to the water from the piping.
- The piping must be clear and free from dirt and blockage. A water leakage test must be carried out to ensure that there is no water leaking before the installation can be made.
- The pipe must be tested by pressure separately. DO NOT test it together with the unit.
- There must be an expansion tank on the top point of the water loop, and the water level inside the tank must be at least 0.5meters higher than the top point of the water loop.
- The flow switch is installed inside of the heat pump, check to ensure that the wiring and action of the switch is normal and controlled by the controller.
- The connection between the heat pump and the construction is best to be of a flexible type to avoid vibration transfer. The support to the water pipe must be separate, but not rely on the heat pump unit.
- Try to avoid any air from being trapped inside the water pipe, there must be an air vent on the top point of the water loop.
- There must be a thermometer and pressure meter at the water inlet and outlet for easy inspection during running.
- There must be drainage on the low points of the water system, and there is already drainage on the chassis of the heat pump. The water in the system must be drained out during winter if the heat pump is not to be used.

4.4 Location of the Unit

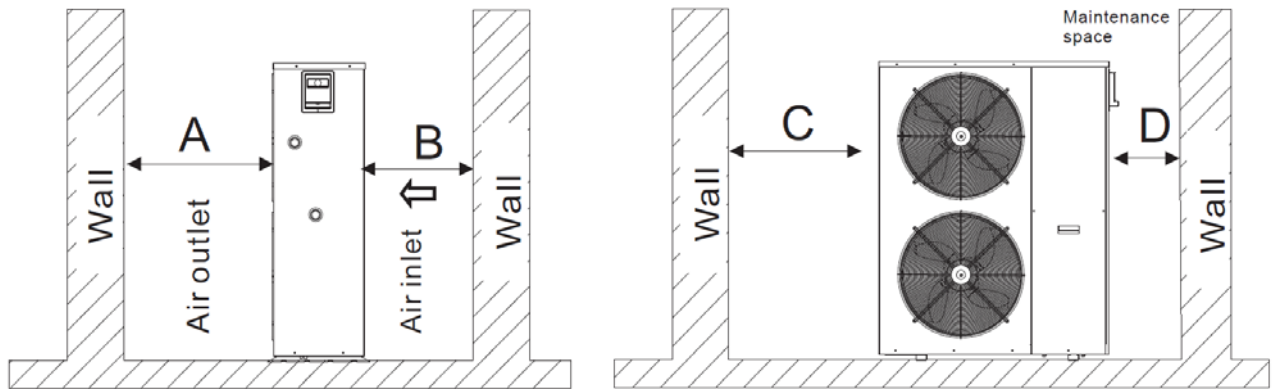

This map only shows a single heat pump positioning.

ATTENTION

Requirement:
 A>1500mm;
 B>1000mm;
 C>500mm;
 D>1000mm.

The size of unit

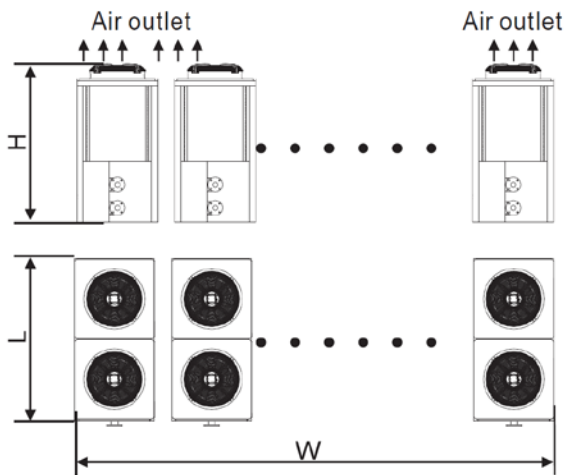

The schematic diagram of installation

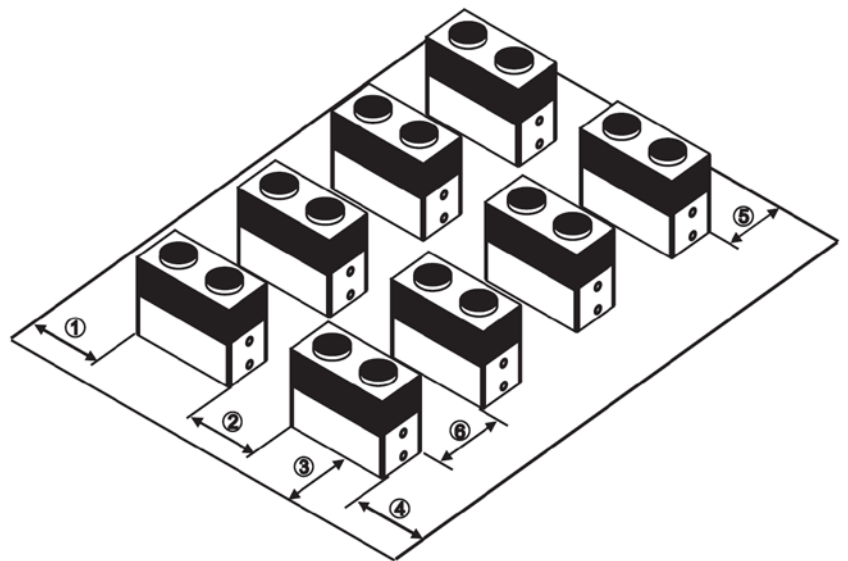

Parallel model	L(mm)	W(mm)	H(mm)
Two units	2180	3160	2100
Three units	2180	5240	2100
Four units	2180	7320	2100
Five units	2180	9400	2100

1	The place for maintenance more than 1500mm
2	The distance between two units more than 1500mm
3	The place for maintenance more than 1500mm
4	The place for maintenance more than 1500mm
5	The place for maintenance more than 1200mm
6	The distance between two units more than 1500mm

4.5 Water Connection Diagram

■ 3 units, different course connection

■ 4 units, same course connection

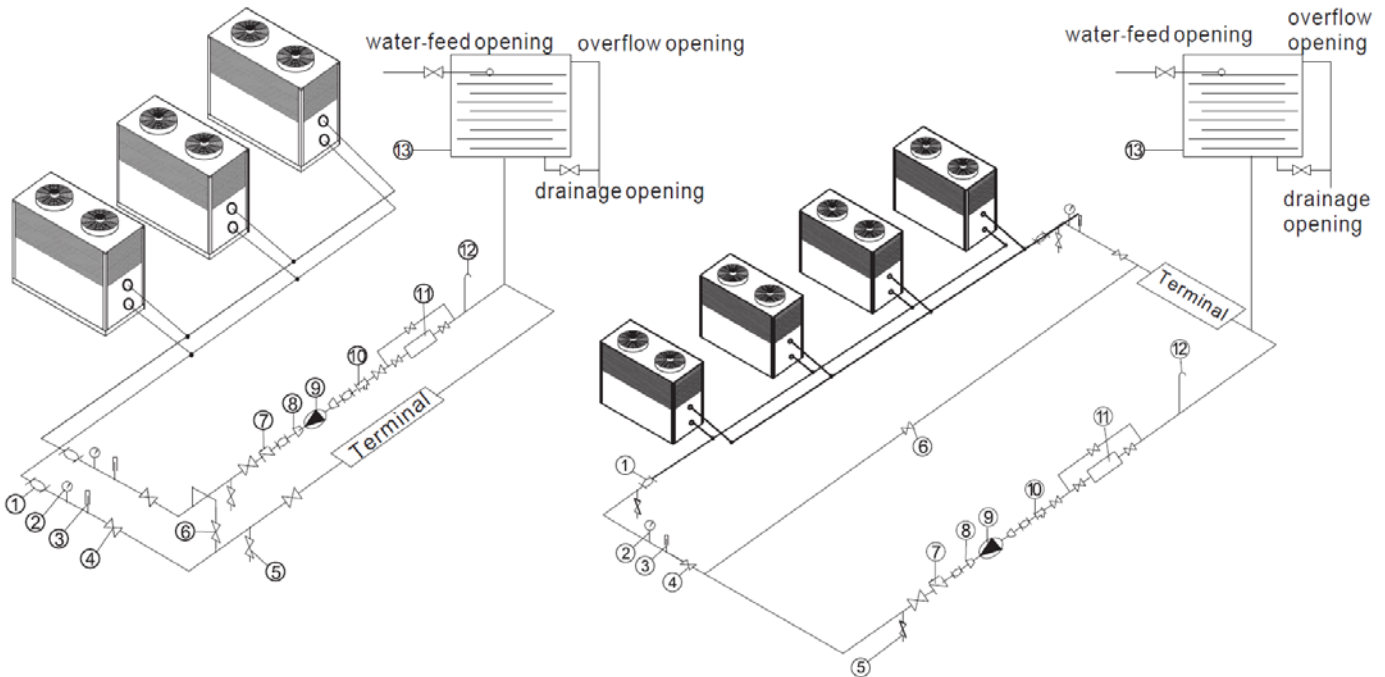

1	rubber connector	4	adjusting valve	7	one way valve	10	Y filter	13	expansion tank
2	gauge	5	drain valve	8	reducer union	11	electric scale-borer		
3	thermometer(0-100°C)	6	bypass valve	9	water pump	12	discharge valve		

4.6 Power Supply Connection

- Open the front panel and open the power supply access.
- The power supply must go through the wire access and be connected to the power supply terminals in the controlling box. Then connect the 3-signal wire plugs of the wire controller and main controller.
- If the outside water pump is needed, please inset the power supply wire into the wire access as well and connect to the water pump terminals.
- If an additional auxiliary heater is needed to be controlled by the heat pump controller, the relay (or power) of the aux-heater must be connected to the relevant output of the controller.

4.7 Cable and Switches

- The unit should use independent power supply, Wiring required by the corresponding table, Power supply voltage must in line with rated voltage.
- Power supply circuit must be equipped with an All-pole disconnect device that has at least 3mm contact opening distance.
- The wiring must be completed by professional technicians in accordance with circuit diagram.
- Power supply circuit must have earth wire, the earth wire of power should be connected with external earth wire safely, and the external earth wire must be in order.
- The creepage protection device must be settled in accordance with the relevant national technical standards for electronic equipment.
- The power wire and signal wire should be neatly arranged. High voltage wire and low voltage wires must be separated and free from any interference, and they must be free from any piping and valves of the unit.
- When all the wiring is completed, the power can only be connected after a double check.

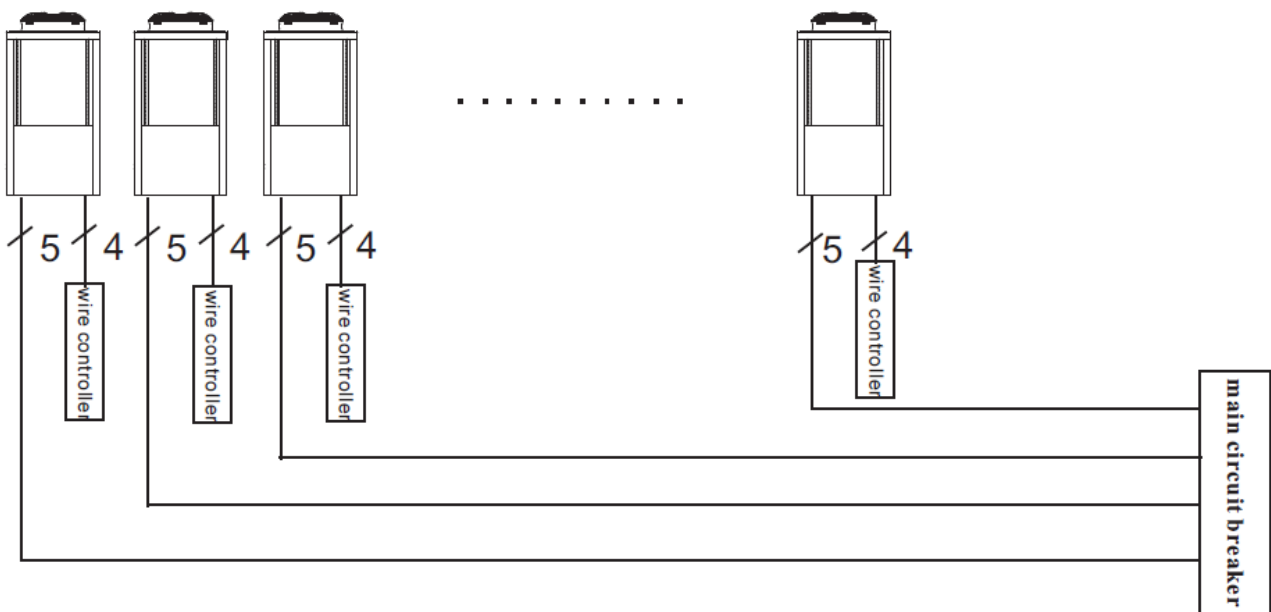

Power Specifications

Unit Model	Power Supply	Cable		MCB	Creepage Protector
		Section area	Earthing wire		
Evo Comfort 19	380-415V/3N~50Hz	Section area	Earthing wire	40A	30mA less than 0.1 second
		4x4mm ²	2.5mm ²		
Evo Comfort 37	380-415V/3N~50Hz	Section area	Earthing wire	80A	30mA less than 0.1 second
		5x16mm ²	16mm ²		
Evo Comfort 50	380-415V/3N~50Hz	Section area	Earthing wire	80A	30mA less than 0.1 second
		5x16mm ²	16mm ²		
Evo Comfort 100	380-415V/3N~50Hz	Section area	Earthing wire	100A	30mA less than 0.1 second
		25x4mm ²	25mm ²		

4.8 Inspection Before Trial Operation

Check the indoor unit, make sure that the pipe connection is done correctly and that the relevant valves are open.

Check the water loop to ensure that there is enough water inside of the expansion tank, that the water supply is good and that the water loop has no air in it and is full of water. Make sure there is good insulation for the water pipe.

Check the electrical wiring. Make sure that the power voltage is normal, the screws are fastened, the wiring is made in line with the diagram and the earthing is connected.

Check that the heat pump, including all the screws and different parts are in good order. When the power is on, review the indicator on the controller to see if there are any failure indications. The gas gauge can be connected to the check valve to see the high pressure (or low pressure) of the system during trial running.

4.9 Trial Operation

Start the heat pump by pressing the 'Power Button' key on the controller. Check whether the water pump is running, if it is running normally there will be 0.2MPa on the water pressure meter.

When the water pump runs for 1 minute, the compressor will start. Hear whether there is a strange sound coming from the compressor. If an abnormal sound occurs, please stop the unit and check the compressor. If the compressor runs well, look for the pressure meter of the refrigerant.

Check whether the power input and running current is in line with the manual. If not stop the unit and check for why this may be occurring.

Adjust the valves on the water loop to make sure that the hot (cool) water supply to each door is good and meets the requirement of heating (or cooling).

Review whether the outlet water temperature is stable.

The parameters of the controller are set by the factory, the user must not change these.



5. Controlling and Operation

5.1 Main Interface Display and Function

5.1.1 Power On Screen



5.1.2 Start Up Screen

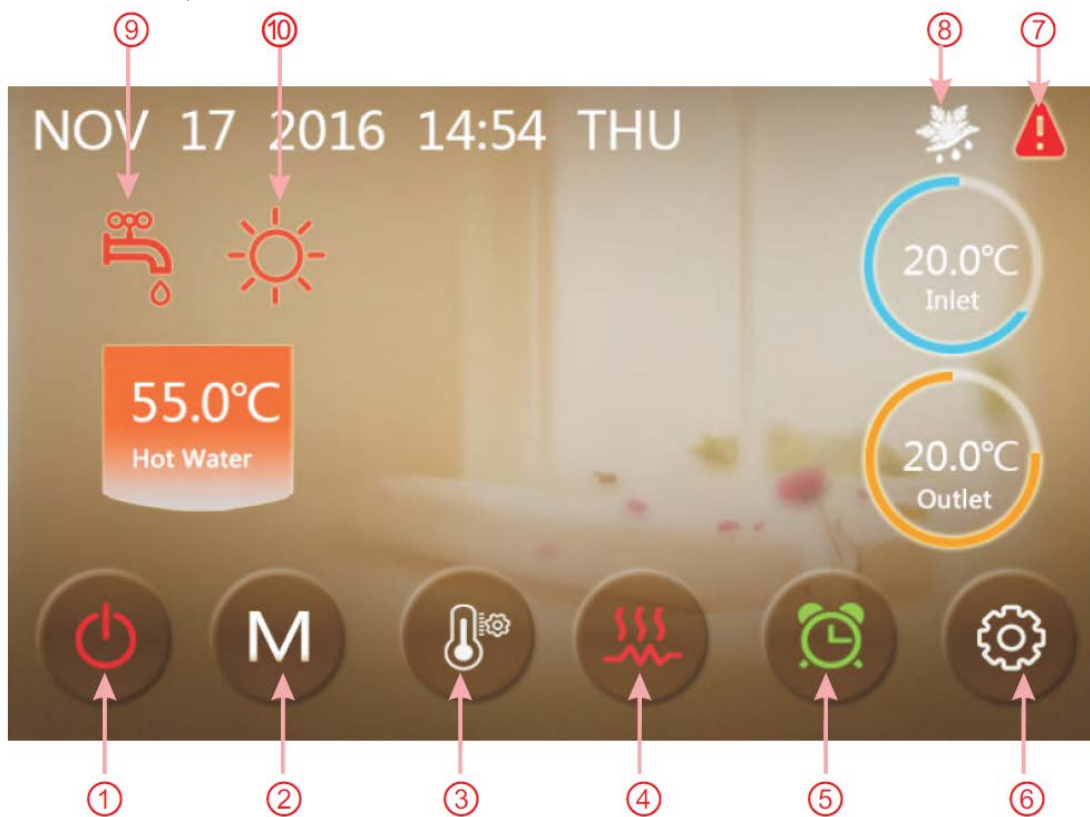

Key Functions

Key No.	Key Name	Key Function
1	On and off	Click this key to switch ON or OFF Red represents ON, while grey represents OFF
2	Mode key	Hot water mode, heating mode, cooling mode, hot water + heating mode or hot water + cooling mode can be selected by pressing this key
3	Temperature setting	Click this to set the target temperature
4	Fast heating	Click this key to start rapid heating This key will be displayed during heating
5	Timer setting	Click this key to set the timer. White represents not enabled, while green represents enabled
6	Setup key	Click this key to check the unit status, time, factory parameters, temperature curve, timer setting and mute setting
7	Fault icon	This icon will flash when there is an error occurring, then the display will enter the failure record interface after tapping this icon

Note:

- 8** is the defrosting icon, the machine is in defrosting mode when this icon is shown
- 9** is the hot water mode icon, this machine is in hot water mode then this icon is shown
- 10** is the heating mode icon, this machine is in heating mode when this icon is displayed

5.2 Wire Controller Usage

5.2.1 On and Off

As the main interface shows

1. In the shut-down interface (on/off key will be in grey), press the on/off key to start the unit
2. In the starting-up interface (on/off key will be red), pressing on/off will turn the unit off

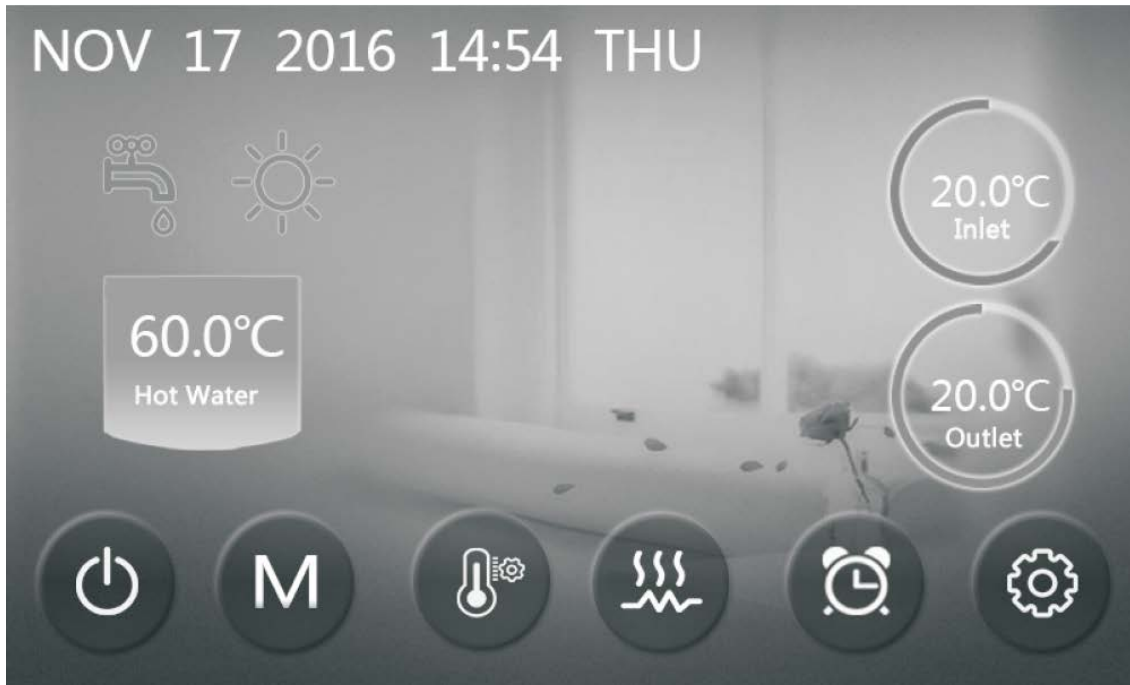

5.2.2 Mode Switch

In the main interface, there are five modes that can be selected after tapping the mode key:

Note: If you have purchased a heating-only model (with no cooling functions), "cooling" mode will not appear

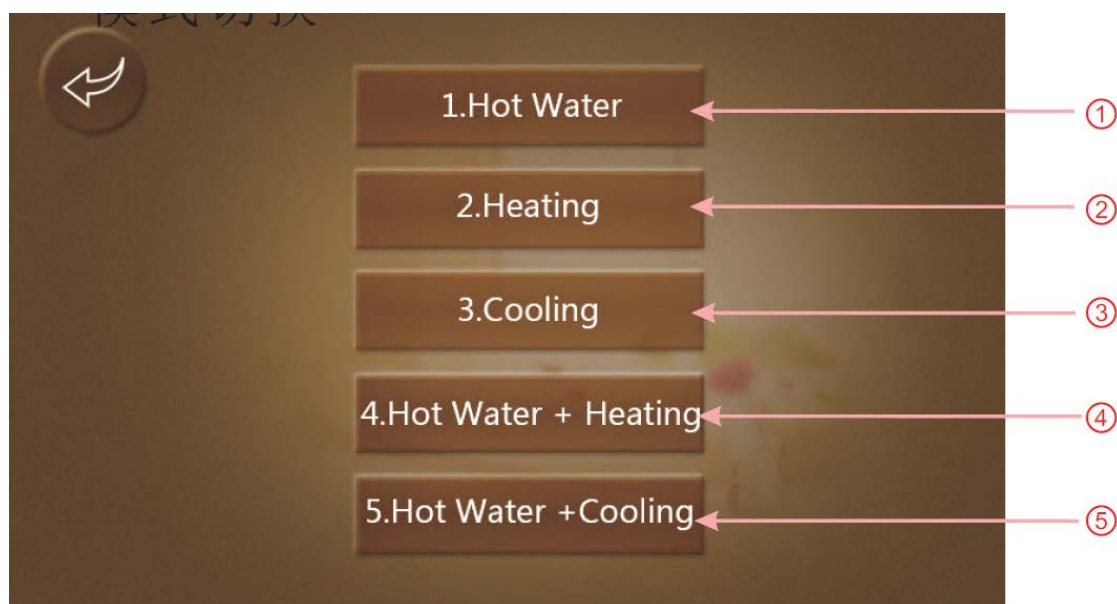

5.2.3 Setting Target Temperature (Hot Water + Cooling Mode Example)

Pressing (1) will bring the controller back to the main interface

Pressing (2) will allow the target temperature to be set, a pop-up keyboard will appear

Pressing (3) will allow the target temperature of cooling mode to be set through the keyboard



When the target temperature is being set, the following keyboard will appear:

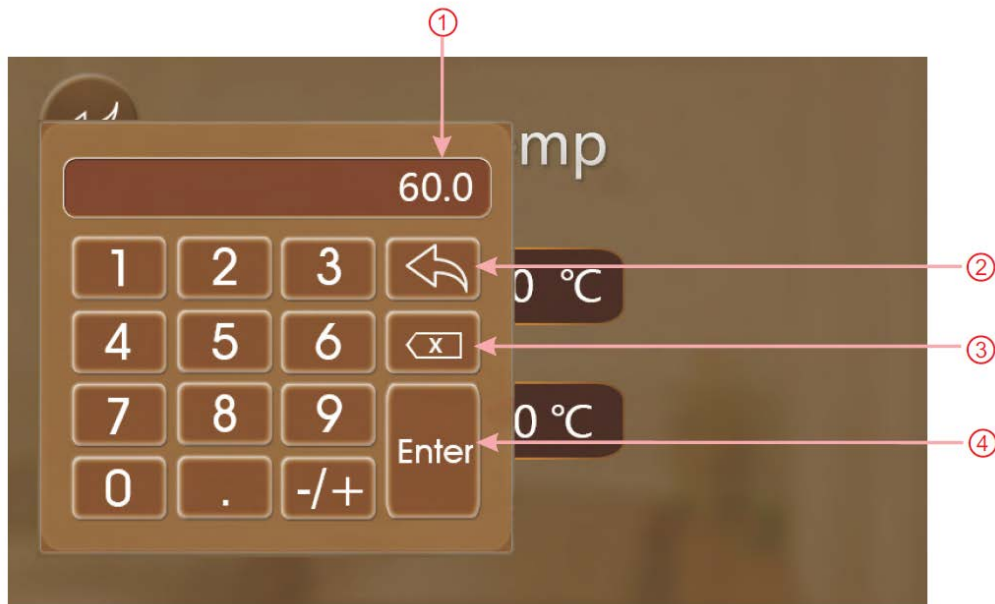

Key No.	Key Name	Key Function
2	Return Key	This key will return you to the main interface
3	Delete Key	This key will undo your last action
4	Enter Key	This key allows you to save your changes and return to the menu

Note: (1) means the new target temperature under the current settings

5.2.4 Fast Heating

Under heating mode, click the fast heating key (1) and the following interface will appear. Click (2) to start fast-heating mode and (3) to close it.

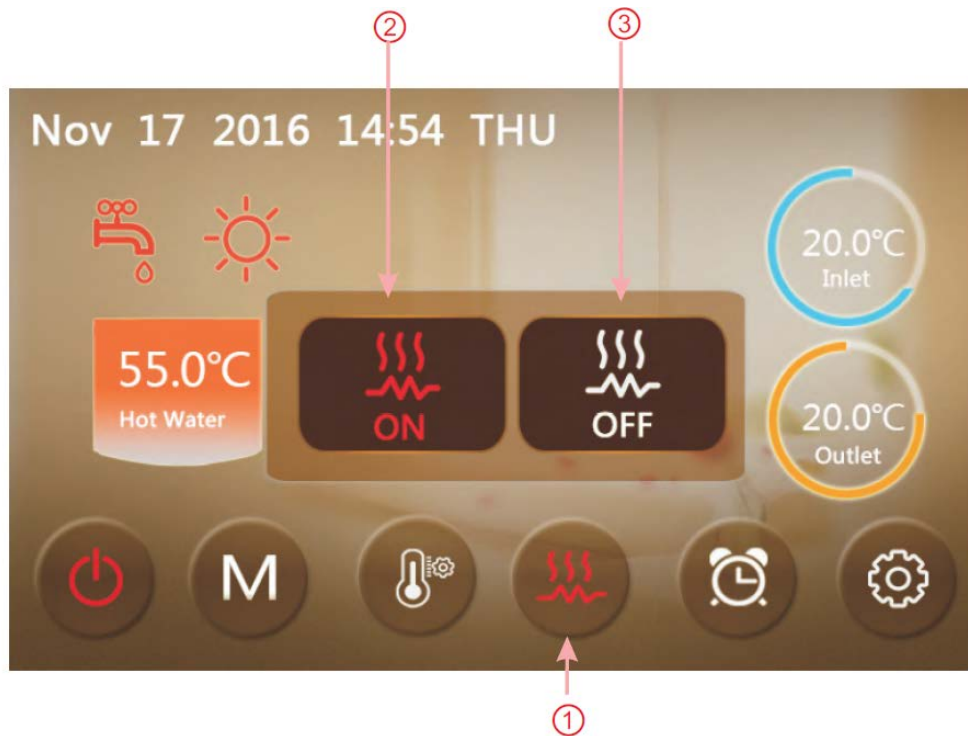

5.2.5 Timer Setting

Click the timer setting key to enter the timer settings and the following interface will appear

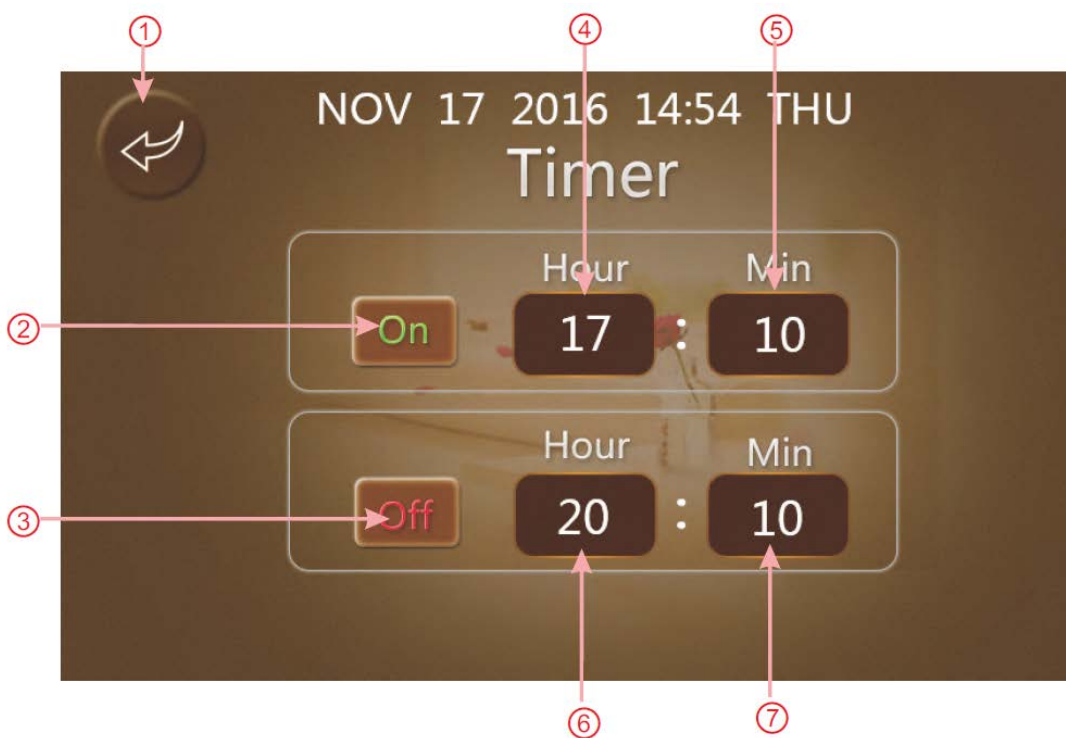

Such as the above figure: Under the state of unmanned operation, it will start the timed start-up at 17:10 and will be timed shutdown when running to 20:10 .

Key No.	Key Name	Key Colour	Key Function
(1)	Return Key		Click this key to return to the main interface
(2)	Enable Timer ON	Enable: Green ON Disable: Grey OFF	Click this key to start or turn off the timed start up function
(3)	Enable Timer OFF	Enable: Green ON Disable: Grey OFF	Click this key to start or turn off the timed start up function
(4)	Hour of Timer ON		Hour of Timer on is shown
(5)	Minute of Timer ON		Minute of Timer on is shown
(6)	Hour of Timer OFF		Hour of Timer off is shown
(7)	Minute of Timer OFF		Minute of Timer off is shown

5.2.6 Fault Interface

Click the fault icon on the main interface and it will display as follows:

Note: (1) Fault code, (2) Fault name, (3) Occurrence time of the fault (day, month, year, hour, seconds), (4) Click this to clear all fault records.

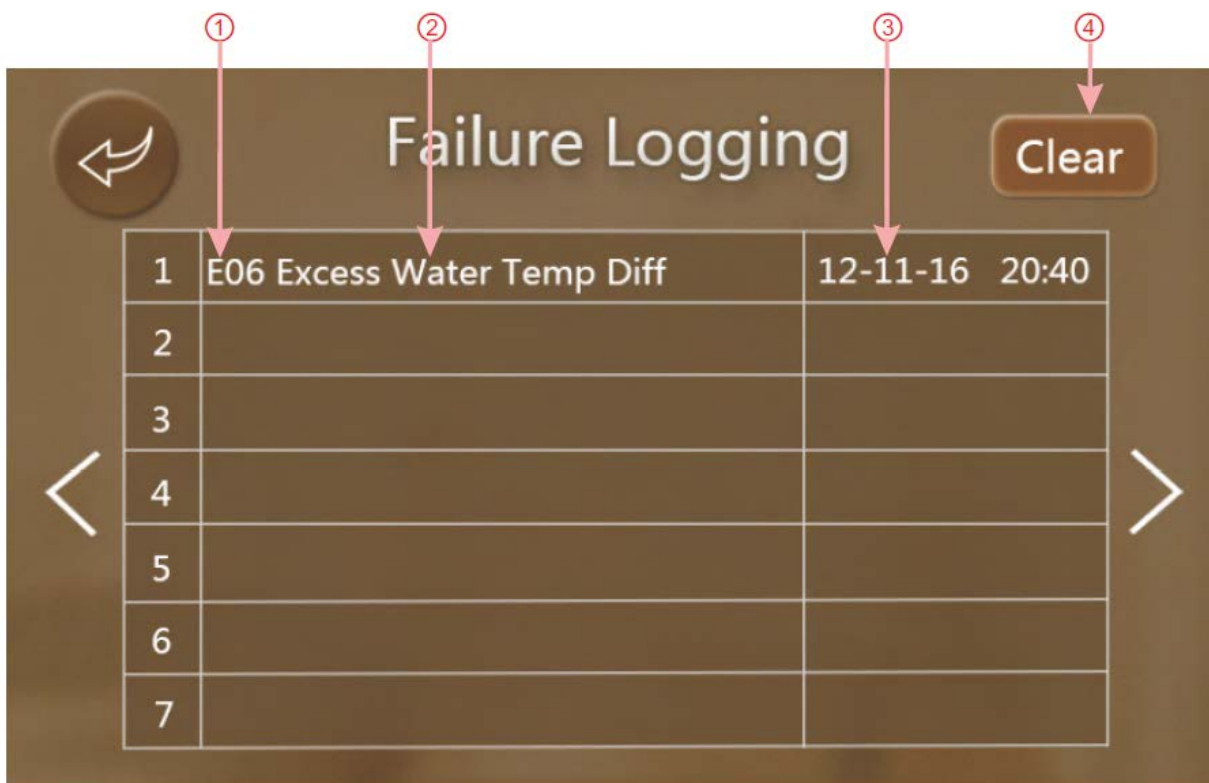

5.2.7 Colour Display Calibration

Keep clicking quickly at the blank area on any interface till you hear a long beep. Then you will enter the calibration interface. Click "+" to start calibration. When you hear the beep again, you will have finished calibration and can exit.

6 Troubleshooting

6.1 Maintenance

- Check the water supply and the air vent frequently to avoid lack of water or air in the water loop.
- Clean the water filter periodically to keep the water good quality. Lack of water and dirty water can damage the unit. The heat pump will start the water every 72 hours when it is not running to avoid freezing.
- Keep the unit in a clean, dry place with good ventilation. Clean the heat exchanger every few months to keep a good heat exchange rate and save energy.
- Check each part of the unit and the pressure of the system. Replace any failing parts and recharge the refrigerant if needed.
- Check the power supply and the electrical system, make sure all electrical components are wired well and working.
- If the heat pump is not to be used for an extended period of time, please drain all the water out. Drain the water out from the lowest point of the heat exchanger to avoid freezing in winter. Water recharge and full inspection on the heat pump is needed before being restarted.
- The water loop of the heat pump **MUST** be protected from freezing in winter. Do not shut off the power supply to the heat pump in winter. When the air temperature is below 0°C, if the inlet water temperature is above 2°C and below 4°C the water pump will begin freezing protection. If the inlet water is lower than 2°C, the heat pump will begin heating.

Please do not shut off the power supply to the heat pump in winter. When the air temperature is below 0C, if the inlet water temperature is above 2°C and below 4°C, the water pump will start freezing protect. If the inlet water is lower than 2 °C, the heat pump will run for heating.

Use anti-freezing liquid (glycol water)

- look at the below table for the volume of the glycol water
- the glycol water can be added into the system from the expansion tank of the water loop.

Glycol Percentage (%)	10	20	30	40	50
Ambient temp (°C)	-3	-8	-14	-22	-33
Cooling/heating capacity fluctuation	0.991	0.982	0.972	0.961	0.946
Power input fluctuation	0.996	0.992	0.986	0.976	0.966
Water flow fluctuation	1.013	1.040	1.074	1.121	1.178
Water drop fluctuation	1.070	1.129	1.181	1.263	1.308

Note: if the glycol water is too much, the water flow and water pump will be influenced, and the heat exchange rate will be decreased. This table is for reference, please use anti-freezing water according to the real condition of the local climate.

6.2 Malfunction Table

Protect/fault	Fault display	Reason	Elimination methods
Standby	Non		
Normal boot	Non		
Inlet Temp Sensor Fault	P01	The temp. Sensor is broken or short circuit	Check or change the temp. sensor
Outlet Temp Sensor Fault	P02	The temp. Sensor is broken or short circuit	Check or change the temp. sensor
Water Tank Temp Sensor	P03	The temp. Sensor is broken or short circuit	Check or change the temp. sensor
AT Sensor Fault	P04	The ambient temp. Sensor is broken or short circuit	Check or change the temp. sensor
Syst1:Coil temp1 Sensor	P153	The temp. Sensor is broken or short circuit	Check or change the temp. sensor
Syst1:Coil temp2 Sensor	P154	The temp. Sensor is broken or short circuit	Check or change the temp. sensor
Syst1:Suction temp Sensor	P17	The temp. Sensor is broken or short circuit	Check or change the temp. sensor
Syst1:Antifreeze Sensor1(US)	P191	The temp. Sensor is broken or short circuit	Check or change the temp. sensor
Syst1:Antifreeze Sensor2(US)	P193	The temp. Sensor is broken or short circuit	Check or change the temp. sensor
Syst1:Antifreeze Sensor4(HSS)	P195	The temp. Sensor is broken or short circuit	Check or change the temp. sensor
Syst1:Inlet Sensor(EVI)	P101	The temp. Sensor is broken or short circuit	Check or change the temp. sensor
Syst1:Outlet Sensor(EVI)	P102	The temp. Sensor is broken or short circuit	Check or change the temp. sensor
Syst1:Exhaust temp Sensor	P181	The temp. Sensor is broken or short circuit	Check or change the temp. sensor
Syst1:Pressure Sensor fault	PP11	The system 1 pressure Sensor is broken or short circuit	Check or change the pressure Sensor or pressure
Syst2:Coil temp Sensor	P25	The temp. Sensor is broken or short circuit	Check or change the temp. sensor
Syst2:Suction temp Sensor	P27	The temp. Sensor is broken or short circuit	Check or change the temp. sensor
Syst2:Antifreeze Sensor1(US)	P291	The temp. Sensor is broken or short circuit	Check or change the temp. sensor
Syst2:Antifreeze Sensor2(US)	P293	The temp. Sensor is broken or short circuit	Check or change the temp. sensor
Syst2:Antifreeze Sensor1(HSS)	P292	The temp. Sensor is broken or short circuit	Check or change the temp. sensor
Syst2:Antifreeze Sensor2(HSS)	P296	The temp. Sensor is broken or short circuit	Check or change the temp. sensor
Syst2:Exhaust Temp Sensor	P281	The temp. Sensor is broken or short circuit	Check or change the temp. sensor
Syst2:Pressure Sensor fault	PP21	The system 2 pressure Sensor is broken or short circuit	Check or change the pressure Sensor or pressure
Syst2:Inlet Sensor(EVI)	P201	The temp. Sensor is broken or short circuit	Check or change the temp. sensor
Syst2:Outlet Sensor(EVI)	P202	The temp. Sensor is broken or short circuit	Check or change the temp. sensor
Syst1:Exhaust Overtemp	P182	The temp. Sensor is broken or short circuit	Check or change the temp. sensor
Syst2:Exhaust Overtemp	P282	The temp. Sensor is broken or short circuit	Check or change the temp. sensor
Low AT Protection	TP	The ambient temp. is low	
Fan Motor1 Fault	F031	1. Motor is in locked-rotor state 2.The wire connection between DC-fan motor module and fan motor is in bad contact	1. Change a new fan motor 2. Check the wire connection and make sure they are in good contact
Fan Motor2 Fault	F032	1. Motor is in locked-rotor state 2.The wire connection between DC-fan motor module and fan motor is in bad contact	1. Change a new fan motor 2. Check the wire connection and make sure they are in good contact
Communication Fault (speed control module)	E081	Speed control module and main board communication fail	Check the communication connection
Communication Fault	E08	Communication failure between wire controller and mainboard	Check the wire connection between remote wire controller and main board
Syst1:Comp Overcurrent	E101	The compressor is overload	Check whether the system of the compressor running normally

Syst2:Comp Overcurrent	E201	The compressor is overload	Check whether the system of the compressor running normally
Syst1: HP Protection	E11	The high-pressure switch is broken	Check the pressure switch and cold circuit
Syst2: HP Protection	E21	The high-pressure switch is broken	Check the pressure switch and cold circuit
Syst1: LP Protection	E12	The low-pressure switch is broken	Check the pressure switch and cold circuit
Syst2: LP Protection	E22	The low-pressure switch is broken	Check the pressure switch and cold circuit
Flow Switch Protection	E032	No water/little water in water system	Check the pipe water flow and water pump
Aux Superheat Protection	E04	The electric-heater protection switch is broken	Check to see whether the electric heater has been running under the temperature over 150°C for a long time
Prim Anti-freezing Prot	E19	The ambient temp. is low	
Secondary Anti-freezing Prot	E29	The ambient temp. is low	
Syst1:Antifreeze(US)	E171	Use side water system temp. is low	<ol style="list-style-type: none"> 1. Check the US water temp. or change the temp. Sensor 2. Check the pipe water flow and whether water system is jammed or not
Syst2:Antifreeze(US)	E271	Use side water system temp. is low	<ol style="list-style-type: none"> 1. Check the US water temp. or change the temp. Sensor 2. Check the pipe water flow and whether water system is jammed or not
Syst1:Antifreeze(HSS)	E172	Heat side water system temp. is low	<ol style="list-style-type: none"> 1. Check the HSS water temp. or change the temp. Sensor 2. Check the pipe water flow and whether water system is jammed or not
Syst2:Antifreeze(HSS)	E272	Heat side water system temp. is low	<ol style="list-style-type: none"> 1. Check the HSS water temp. or change the temp. Sensor 2. Check the pipe water flow and whether water system is jammed or not
Syst1:Exhaust Overtemp	E182	The compressor is overload	Check whether the system of the compressor running normally
Syst2:Exhaust Overtemp	E282	The compressor is overload	Check whether the system of the compressor running normally
Excess Water Temp Diff	E06	Water flow is not enough and low pressure difference	Check the pipe water flow and whether water system is jammed or not

6.3 Parameter List

Meaning	Default	Remarks
Cooling target temperature set point	12°C	Adjustable
Heating the target temperature set point	50°C	Adjustable
Hot water target temperature set point	55°C	Adjustable



7 Main Controller Terminals

7.1 Wire Control Interface Diagram and Definition

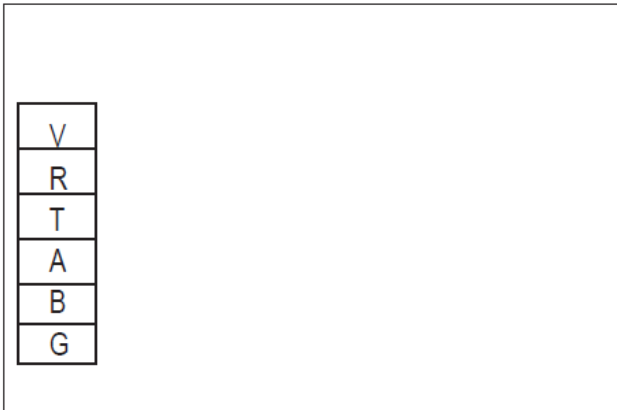

Sign	Meaning
V	12V (power +)
R	No use
T	No use
A	485A
B	485B
G	GND(power-)

7.2 The Main Controller Terminals

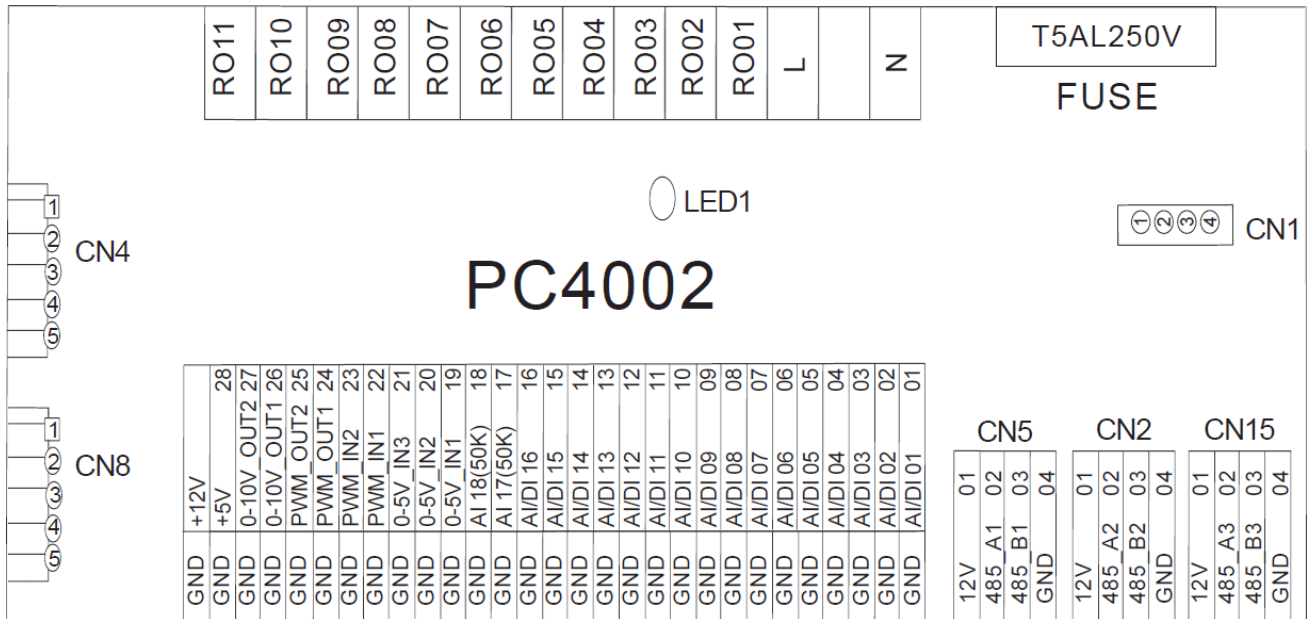

Main board of the input and output interface instructions below:

Number	Sign	Meaning
01	AI/DI01	Water input temperature
02	AI/DI02	Water output temperature
03	AI/DI03	System 1 coil temperature
04	AI/DI04	Ambient temperature
05	AI/DI05	System 1 suction temperature
06	AI/DI06	System1 Antifreeze 1 Temperature / System 1 Coil temperature 2
07	AI/DI07	System1 Antifreeze 2 Temperature
08	AI/DI08	Water tank Temperature
09	AI/DI09	System1 Antifreeze 4 Temperature
10	AI/DI10	Temperature of the EVI inlet of system 1
11	AI/DI11	Temperature of the EVI outlet of system 1
12	AI/DI12	The high-pressure switch 1
13	AI/DI13	The low-pressure switch 1
14	AI/DI14	Water flow switch protection
15	AI/DI15	Emergency switch output
16	AI/DI16	Mode switch
17	AI17 (50K)	Overload switch of electric heater
18	AI18 (50k)	System Exhaust temperature 1
19	0~5V_IN1	System 1 compressor current detection
20	0~5V_IN2	Water level sensor
21	0~5V_IN3	pressure sensor 1
22	PWM_IN1	System flow meter (reserved)
23	PWM_IN2	No use
24	PWM_OUT1	AC Fan control output
25	PWM_OUT2	No use
26	0~10V_OUT1	No use
27	0~10V_OUT2	No use
28	+5V	5V output
29	+12V	12V output
30	CN1	Communication ports on the expansion board
31	CN2	Centralized control port
32	CN4	Electronic expansion valve 1
33	CN5	Colour line controller
34	CN8	Electronic expansion valve of EVI in system 1
35	CN15	DTU
36	RO11	Electromagnetic three-way valve 2
37	RO10	Electromagnetic three-way valve 1
38	RO09	Hot water pump
39	RO08	Alarm output
40	RO07	AUX superheat
41	RO06	4-way valve
42	R005	Water pump
43	R004	Fan 2 / Fan low speed
44	R003	Fan 1 / Fan high speed
45	R002	Compressor 2
46	R001	Compressor 1

7.3 Connection of PCB Illustration

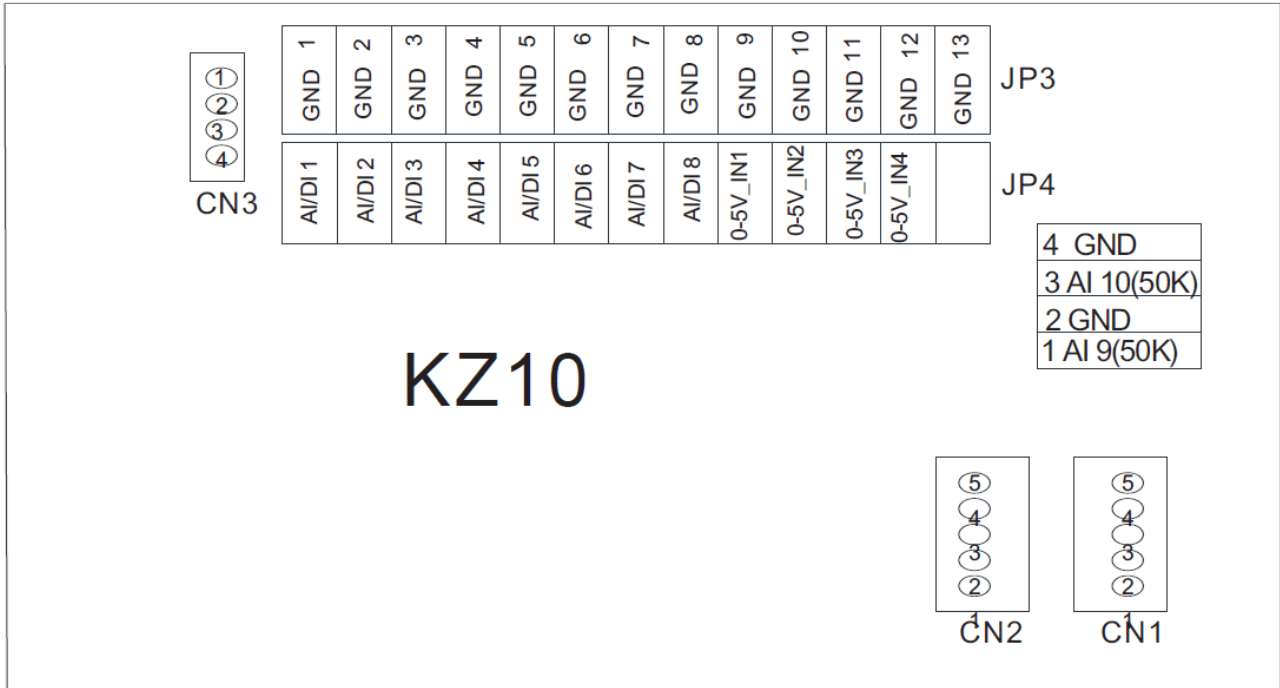

The description of the input and output interface of the extended module is as follows:

Temperature 2

AI/DI01	System 2 fan coil temperature	AI 10(50K)	Reserved
AI/DI02	System 2 suction temperature	GND	Ground
AI/DI03	System2 Antifreeze 1 Temperature	AI 9(50K)	System 2 Exhaust temperature
AI/DI04	System2 Antifreeze 2 Temperature	CN1	Electronic expansion valve A
AI/DI05	System2 Antifreeze 3 Temperature (Temperature of the EVI inlet of system 2)	CN2	Electronic expansion valve of EVI in system 2
AI/DI06	System2 Antifreeze 4 Temperature (Temperature of the EVI outlet of system 2)	CN3	Communication port
AI/DI07	System 2 the high-pressure switch		
AI/DI08	System 2 the low-pressure switch		
0~5V_IN1	System 2 compressor current detection		
0~5V_IN2	System 2 pressure sensor		
0~5V_IN3	Reserved		
0~5V_IN4	Reserved		
+5V	+5V		

7.4 Common Observations

FAILURE	POSSIBLE CAUSES	SOLUTIONS
Heat pump cannot be started	Wrong power supply	Shut off the power and check power supply
	Power supply cable loose	Check power cable and correct the connection
	Circuit breaker open	Check for the cause and replace the fuse or circuit breaker
Water pump is running with high Noise or without water	Lack of water in the piping	Check the water supply and charge water to the piping
	Too much air in the water loop	Discharge the air in the water loop
	Water valves closed	Open the valves in water loop
	Dirt and block on the water filter	Clean the water filter
Heat pump capacity is low, compressor does not stop	Lack of refrigerant	Check for the gas leakage and Recharge the Refrigerant
	Bad insulation on water pipe	Make good insulation on water pipe
	Low heat exchange rate on air Side exchanger	Clean the air side heat exchanger
	Lack of water flow	Clean the water filter
High compressor exhaust	Too much refrigerant	Discharge the redundant gas
	Low heat exchange rate on air side exchanger	Clean the air side heat exchanger
Low pressure problem of the system	Lack of gas	Check the gas leakage and recharge freon
	Block on filter or capillary	Replace filter or capillary
	Lack of water flow	Clean the water filter and discharge the air in water loop
Compressor does not run	Power supply failure	Check off the power supply
	Compressor contactor broken	Replace compressor contactor
	Power cable loose	Tighten the power cable
	Protection on compressor	Check the compressor exhaust temp.
	Wrong setting on return water Temp.	Reset the return water temp
	Lack of water flow	Clean the water filter and discharge the air in water loop
High noise of compressor	Liquid refrigerant goes into Compressor	Bad evaporation check the cause for bad evaporation and get rid of it
	Compressor failure	Use new compressor
Fan does not run	Failure on fan relay	Replace the fan relay
	Fan motor broken	Replace fan motor
The compressor runs but heat Pump has no heating or cooling capacity	No gas in the heat pump	Check system leakage and recharge refrigerant
	Heat exchanger broken	Find out the cause and replace the heat exchanger
	Compressor failure.	Replace compressor
Low outlet water temperature	Low water flow rate	Clean the water filter and discharge the air in water loop
	Low setting for the desired water temp	Reset the desired water temperature
Low water flow protection	Lack of water in the system	Clean the water filter and discharge the air in water loop
	Failure on flow switch	Replace the flow switch

8 Appendix

8.1 Caution & Warnings

The unit can only be repaired by qualified personnel or an authorised dealer.

This appliance is not intended for use by persons (including children) with reduced physical sensory or mental capabilities, or lack of experience and knowledge, unless they have been given supervision or instruction concerning use of the appliance by a person responsible for their safety.

Children should be supervised to ensure that they do not play with the appliance.

Please make sure that the unit and power connection have good earthing, otherwise there is a risk of electrical shock.

If the supply cord is damaged, it must be replaced by the manufacturer, our service agent or a similarly qualified person in order to avoid a hazard.

Directive 2002/96/EC (WEEE):

The symbol depicting a crossed-out waste bin that is underneath the appliance indicates that this product at the end of its useful life, must be handled separately from domestic waste, and must be taken to a recycling centre for electric and electronic devices or handed back to the dealer when purchasing an equivalent appliance.

Directive 2002/95/EC (RoHs): This product is compliant with directive 2002/95/EC (RoHs) concerning restrictions for the use of harmful substances in electric and electronic devices.

The unit CANNOT be installed near flammable gas. If there is any leakage of the gas a fire can occur.

Make sure that there is circuit breaker for the unit, lack of circuit breaker can lead to electrical shock or fire.

The heat pump located inside the unit is equipped with an over-load protection system. It does not allow for the unit to start for at least 3 minutes from a previous stoppage.

The unit can only be repaired by the qualified personnel of an installer center or an authorized dealer.

Installation must be performed in accordance with the NEC/CEC by authorized person only (for North America market)

USE SUPPLY WIRES SUITABLE FOR 75°C.

Caution: Single wall heat exchanger, not suitable for potable water connection.



8.2 Cable Specifications

Single Phase Unit

Nameplate max. current	Phase Line	Earth Line	MCB	Creepage Protector	Signal Line
No More than 10A	2 x 1.5mm ²	1.5mm ²	20A	30mA less than 0.1 sec	n x 0.5mm ²
10~16A	2 x 2.5mm ²	2.5mm ²	32A	30mA less than 0.1 sec	
16~25A	2 x 4mm ²	4mm ²	40A	30mA less than 0.1 sec	
25~32A	2 x 6mm ²	6mm ²	40A	30mA less than 0.1 sec	
32~40A	2 x 10mm ²	10mm ²	63A	30mA less than 0.1 sec	
40~63A	2 x 16mm ²	16mm ²	80A	30mA less than 0.1 sec	
63~75A	2 x 25mm ²	25mm ²	100A	30mA less than 0.1 sec	
75~101A	2 x 25mm ²	25mm ²	125A	30mA less than 0.1 sec	
101~123A	2 x 35mm ²	35mm ²	160A	30mA less than 0.1 sec	
123~148A	2 x 50mm ²	50mm ²	225A	30mA less than 0.1 sec	
148~186A	2 x 70mm ²	70mm ²	250A	30mA less than 0.1 sec	
186~224A	2 x 95mm ²	95mm ²	280A	30mA less than 0.1 sec	

Three Phase Unit

Nameplate max. current	Phase Line	Earth Line	MCB	Creepage Protector	Signal Line
No More than 10A	3 x 1.5mm ²	1.5mm ²	20A	30mA less than 0.1 sec	n x 0.5mm ²
10~16A	3 x 2.5mm ²	2.5mm ²	32A	30mA less than 0.1 sec	
16~25A	3 x 4mm ²	4mm ²	40A	30mA less than 0.1 sec	
25~32A	3 x 6mm ²	6mm ²	40A	30mA less than 0.1 sec	
32~40A	3 x 10mm ²	10mm ²	63A	30mA less than 0.1 sec	
40~63A	3 x 16mm ²	16mm ²	80A	30mA less than 0.1 sec	
63~75A	3 x 25mm ²	25mm ²	100A	30mA less than 0.1 sec	
75~101A	3 x 25mm ²	25mm ²	125A	30mA less than 0.1 sec	
101~123A	3 x 35mm ²	35mm ²	160A	30mA less than 0.1 sec	
123~148A	3 x 50mm ²	50mm ²	225A	30mA less than 0.1 sec	
148~186A	3 x 70mm ²	70mm ²	250A	30mA less than 0.1 sec	
186~224A	3 x 95mm ²	95mm ²	280A	30mA less than 0.1 sec	

When this unit is to be installed outdoors, please use a UV resistant cable.